

New!

FP series

Fully illuminated pushbutton switches - bushing Ø 26 mm - momentary or latching

Distinctive features and specifications



Full actuator or symbol illumination

FP26-1706A-R2

Suited for integrated designs

Large but lightweight

Snap-in mounting

Pad printed or laser etched symbols

	Pad printing	Laser
Non-illuminated		
Illuminated		

ELECTRICAL SPECIFICATIONS

- Max. current/voltage rating with resistive load :
 - silver contacts (code 2) : 4A 12VDC
 - gold plated contacts (code 4) : 200mA 12VDC
- Initial contact resistance : 50 mΩ max.
- Insulation resistance : 1 GΩ min. at 500VDC
- Dielectric strength : 1.000 Vrms 50 Hz min.
- Electrical life at full load :
 - Momentary models : 1 million cycles (gold plated contacts)
400.000 cycles (silver contacts)
 - Latching models : 200.000 cycles

MATERIALS

- Case : PA46
- Actuator : PA12
- Bushing/ bezel : ABS
- Contacts : silver (code 2)
or silver, gold plated (code 4)

GENERAL SPECIFICATIONS

- Front panel sealing : IP54 according to IEC 60529 with panel gasket and 2 mm panel thickness
- Panel thickness : 1,5 (.059) to 2 mm (.078) with panel gasket
2 (.078) to 2,5 mm (.885) without panel gasket
- Total travel : 2,5 mm ± 0,5 mm
- Typical operating force : 8N ± 2N
- Low level or mechanical life :
 - Momentary models : 1 million cycles
 - Latching models : 200.000 cycles
- Operating temperature : -40°C to +75°C

WIRING DIAGRAM

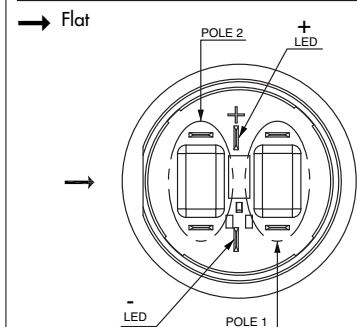

FP series

New!

Fully illuminated pushbutton switches - bushing Ø 26 mm - momentary or latching

Overview

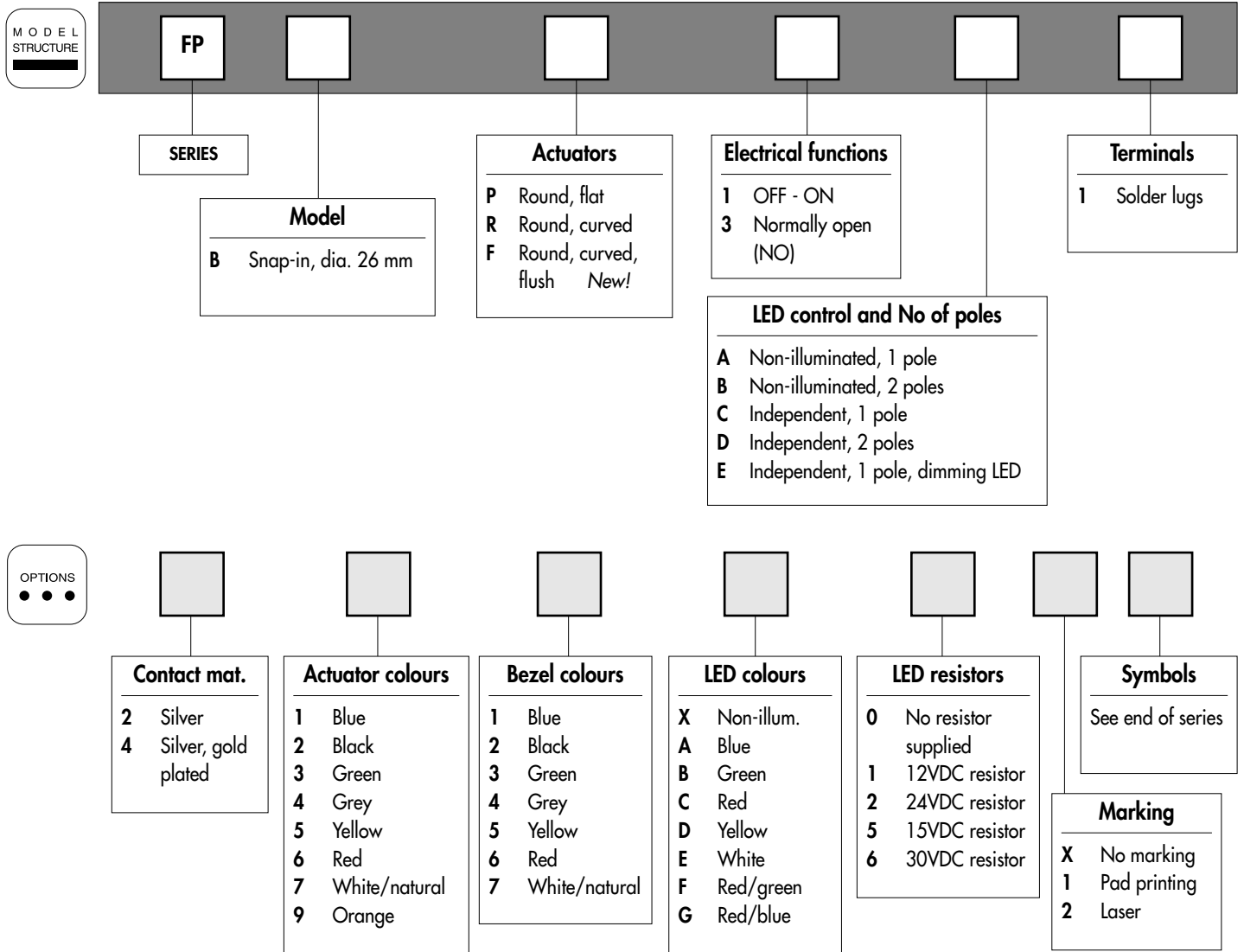

ABOUT THIS SERIES

On the following pages, you will find successively :
model structure of switches and options in the same order as in above chart

Dimensions : first dimensions are in mm while inches are shown as bracketed numbers.



NOTICE : please note that not all combinations of above numbers are available.
Refer to the following pages for further information.



Mounting accessories : Standard hardware supplied : 1 hex nut and 1 panel gasket



Packaging unit : 20 pieces



New!

FP series

Fully illuminated pushbutton switches - bushing Ø 26 mm - momentary or latching

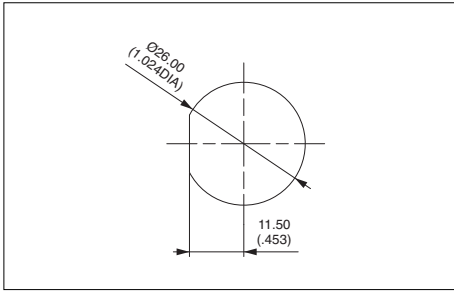

- Curved or flat actuator

To order a product, replace • with one of the codes selected under "LED control and number of poles" below, then add the desired options.

MODEL STRUCTURE

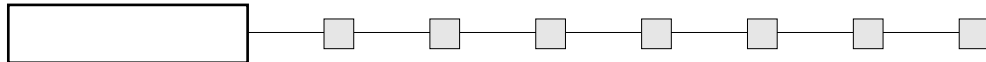

Solder lug terminals



- LATCHING**
 Curved actuator
FPBR1•1
 Flat actuator
FPBP1•1
- MOMENTARY (NO)**
 Curved actuator
FPBR3•1
 Flat actuator
FPBP3•1

OFF - ON

OFF ON



→ Flat

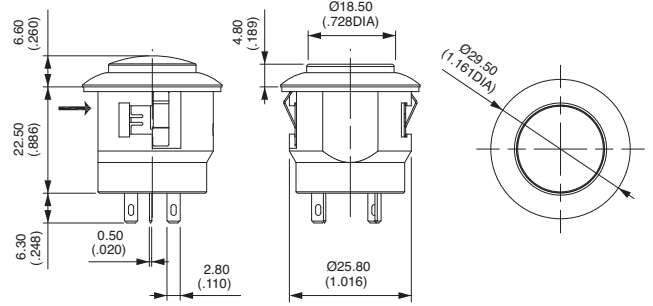

LED CONTROL AND NUMBER OF POLES

Complete the model numbers above with one of the following codes.

	Function 1 (latching)	Function 3 (momentary)
Non-illuminated one pole A		
Non-illuminated two poles B		

	Function 1 (latching)	Function 3 (momentary)
Independent one pole C		
Independent two poles D		
Independent one pole Dimming LED E		

dotted line = jumper to be wired by the user. LED- has to be wired to one pin of pole 2.

CONTACT MATERIALS

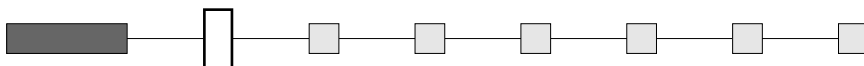

- 2 Silver
- 4 Silver, gold plated

FP series

New!



Fully illuminated pushbutton switches - bushing Ø 26 mm - momentary or latching

Options

ACTUATOR COLOURS

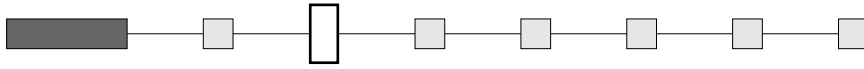

1 : blue - 2 : black - 3 : green - 4 : grey - 5 : yellow - 6 : red - 7 : white/natural - 9 : orange

BEZEL COLOURS

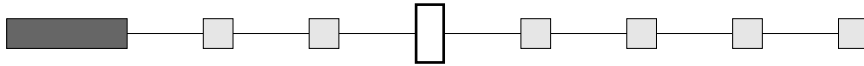

1 : blue - 2 : black - 3 : green - 4 : grey - 5 : yellow - 6 : red - 7 : white/natural

LED COLOURS

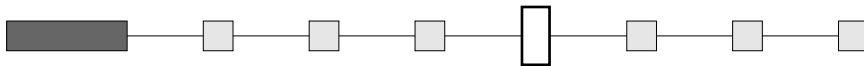

X : non-illuminated

A : blue - B : green - C : red - D : yellow - E : white - F : red/green - G : red/blue

LED RESISTORS

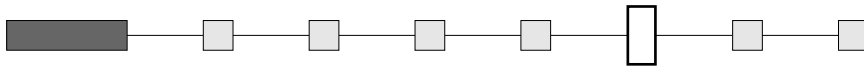

- 0 No resistor supplied
- 1 12VDC resistor
- 2 24VDC resistor
- 5 15VDC resistor
- 6 30VDC resistor

MARKING

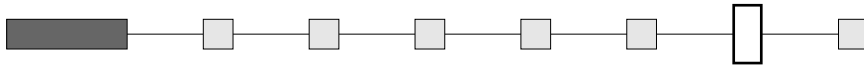

- X No marking
- 1 Pad printing
- 2 Laser



New!

FP series

Fully illuminated pushbutton switches - bushing Ø 26 mm - momentary or latching

Options

SYMBOLS

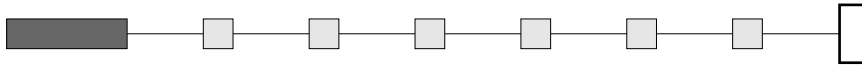

Blank No symbol

Available symbols - see next pages.

Marking colour

White marking for illuminated actuators (laser etching) and non-illuminated black actuators (pad printing). Black marking for non-illuminated colour actuators (pad printing). Other : on request.

Marking area

The symbol will be included in the hatched area.

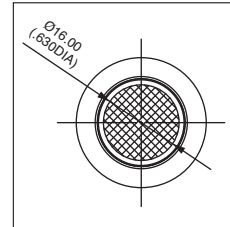

→ Flat



FP series

Fully illuminated pushbutton switches - bushing Ø 26 mm - momentary or latching

Symbols

Most symbols meet the ISO 7000 standard "graphical symbols for use on equipments" (code given in bracket in the description). Contact us for symbols not featured in the following tables.

Legend scale :









































Depending on space available on the product (see "Symbols" section).

CODE	SYMBOL	DESCRIPTION	CODE	SYMBOL	DESCRIPTION	CODE	SYMBOL	DESCRIPTION
XX	None	-	16		Revolving light	32		Emergency first aid vehicle (2565)
01	ON	-	17		Rear ventilator	33		Load tipping (1557)
02	OFF	-	18		Heating (0637)	34		Loading light (2457)
03	○	-	19		Door opening	35		Tractor, rear-ward (1667)
04	I	-	20		Windshield demister/defroster (0635)	36		Combine, direction of movement (1678)
05	II	-	21		Windshield wiper (0086)	37		Use no forks (2406)
06	STOP	-	22		Windshield washer (0088)	38		Transmission (1166)
07	A	Stop	23		Ventilator fan (0089)	39		Working spot light (1145)
08	M	Motion	24		Side mirror defroster	40		Engine (0640)
09		Up motion	25		Restarting pump	41		Horn (0244)
10		Down motion	26		Front fog lights (0633)	42		Lock (1656)
11		Hot	27		Rear fog lights (0634)	43		Taxi sign light (2551)
12		Cold	28		Propulsion system trim	44		Working light (1204)
13		Hazard warning (0085)	29		Beacon (1141)	45		Working light symmetric (1204)
14		Traveller lighting	30		Anchor	46		-
15		Driver lighting (1421)	31		Electric motor (0011)	47	ASM	-

Most symbols meet the ISO 7000 standard "graphical symbols for use on equipments" (code given in bracket in the description). Contact us for symbols not featured in the following tables.

Legend scale :

Depending on space available on the product (see "Symbols" section).

CODE	SYMBOL	DESCRIPTION	CODE	SYMBOL	DESCRIPTION	CODE	SYMBOL	DESCRIPTION
48		All wheel drive	64		Indicator	80		Front windshield heating
49		Differential lock (1662)	65		Brake release	81	AUS	Aus
50		-	66		Baggage room left door	82		Radiator fan
51		-	67		Baggage room right door	83		Remove retarder
52		-	68		Power blinds	84		Restricted speed
53	N	-	69		Engine idle control	85		Preheater
54		Rear window wiper (0097)	70	CRUISE RES/SET	Cruise res/set	86		ABS detection
55		Rear window washer (0099)	71		Driver windows up/down	87		ECAS detection
56		Lower load (2223)	72		Middle door opening	88		Engine stop
57		Cab lock (1560)	73		Front door opening	89	CRUISE RES/CAN	Cruise res/cancel
58		Extraction	74		Lighting in baggage room	90		ECAS reset
59		Pumping in	75	CRUISE ON/OFF	Cruise on/off	91		Driver windows heating
60		Rear PTO (1572)	76	TV	TV	92	CRUISE SET+/SET-	Cruise set
61		Front PTO	77		Pump	93		Air bag up/down
62		Rockshaft down	78	WC	Toilet	94		Read lighting
63		Rockshaft up	79		Toilet decontamination	95		Lighting main switch

FP series





































Fully illuminated pushbutton switches - bushing Ø 26 mm - momentary or latching

Symbols

Most symbols meet the ISO 7000 standard "graphical symbols for use on equipments" (code given in bracket in the description). Contact us for symbols not featured in the following tables.

Legend scale :

Depending on space available on the product (see "Symbols" section).

CODE	SYMBOL	DESCRIPTION	CODE	SYMBOL	DESCRIPTION	CODE	SYMBOL	DESCRIPTION
96		Heating using water	AD		-	AV		-
97		Low beam	AE		-	AW		-
98		Position lights	AF		-	AY		-
99		Diesel acceleration	AG		Battery charging condition (0247)	AZ		-
A1		Manual mode	AH		Turn signals (0084)	B1	HIGH	-
A2		Clockwise cabin rotation	AJ		High beam (0082)	B2	LOW	-
A3		Anticlockwise cabin rotation	AK		Differential lock, bogie (2600)	B3		-
A4		-	AL		Brushing with a rotating brush (0070)			
A5		-	AM		Differential lock, transfer case 4x4 (2475)			
A6		Parking brake	AN		Loader bucket, float (1441)			
A7		-	AP		Loader bucket (1437)			
A8		-	AQ		Rear window washer & wiper (0098)			
A9		-	AR		Header Header drive (1579)			
AA		-	AS		Excavator/backhoe boom side shift (2091)			
AB		-	AT		Chemical water treatment (1851)			
AC		-	AU		Grapple skidder, single funct° boom (1762)			