

Gear Pump – High Performance Version

GPO

Displacement up to 3,2 cm³ (0.20 inch³) • p_{max} 260 bar (3800 PSI) • Speed from 500 to 8000 RPM



Technical Features

- › Operating pressure 230 bar, Peak pressure 260 bar
- › High-strength quality aluminum alloys pump with axial play compensation
- › Low noise level in whole operating range
- › High operational reliability and service life for 3000 operation hours
- › High volumetric efficiency up to 98%
- › International standard flanges acc.to SAE, ISO, DIN, GOST

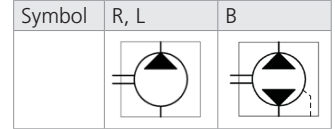

Technical Data

Nominal Size Parameters	Symbol	Unit	Displacement															
			0,18	0,25	0,32	0,36	0,40	0,50	0,63	0,70	0,80	1,00	1,25	1,50	2,00	2,50	3,20	
Actual displacement	V _g	[cm ³]	0,175	0,256	0,327	0,361	0,408	0,501	0,630	0,711	0,804	1,001	1,258	1,514	2,004	2,505	3,192	
		[in ³]	0,011	0,016	0,020	0,022	0,025	0,031	0,038	0,043	0,049	0,061	0,077	0,092	0,122	0,153	0,195	
Rotation speed	nominal	n _n	1500															
	minimum	n _{min}	1000															
	maximum	n _{max}	8000	7000				6000				5000	4000	3000	2800	2500	1800	
Pressure at inlet*	minimum	p _{1min}	-0,3 (-4.4 PSI)															
	maximum	p _{1max}	0,5 (7.3 PSI)															
Pressure at outlet**	max. continuous	p _{2n}	[bar]	200	230				220				200	160	120	90	60	
		[PSI]	2901	3336				3191				2901	2321	1740	1305	870		
	maximum	p _{2max}	[bar]	250						240				220	180	150	100	70
		[PSI]	3625						3481				3191	2611	2176	1450	1015	
peak	p ₃	[bar]	260						250				230	190	160	110	80	
	[PSI]	3771						3625				3336	2756	2321	1595	1160		
Nominal flow rate (min.) at n _n and p _{2n}	Q _n	[l min ⁻¹]	0,19	0,30	0,40	0,44	0,50	0,65	0,85	0,95	1,05	1,35	1,70	2,00	2,70	3,40	4,45	
		[GPM]	0,05	0,08	0,11	0,12	0,13	0,17	0,22	0,25	0,28	0,36	0,45	0,53	0,71	0,90	1,18	
Maximum flow rate at n _{max} and p _{2max}	Q _{max}	[l min ⁻¹]	1,39	1,77	2,27	2,50	2,83	2,98	3,74	4,22	4,78	4,95	4,98	4,50	5,56	6,20	5,69	
		[GPM]	0,37	0,47	0,60	0,66	0,75	0,79	0,99	1,11	1,26	1,31	1,32	1,19	1,47	1,64	1,50	
Nominal input power (max.) at n _n and p _{2n}	P _n	[kW]	0,10	0,17	0,22	0,24	0,28	0,34	0,41	0,46	0,52	0,59	0,74	0,71	0,71	0,66	0,56	
Maximum input power at n _{max} and p _{2max}	P _{max}	[kW]	0,69	0,88	1,12	1,24	1,40	1,40	1,78	2,01	2,27	2,16	2,17	1,60	1,65	1,23	0,79	
Weight	m	[kg]	0,37	0,38	0,38	0,38	0,39	0,39	0,40	0,40	0,40	0,41	0,41	0,43	0,45	0,48	0,53	
		[lbs]	0,82	0,84	0,84	0,84	0,86	0,86	0,88	0,88	0,88	0,88	0,90	0,90	0,95	0,99	1,06	1,17

- 1) *Inlet pressure in the reversible design can be up to **p₁ = p_{2n} -70 bar max.** External drainage must be used in case of the reversible design.
- 2) **Outlet pressure in the reversible design is 10% lower than shown in the table (depending on operating conditions).
- 3) **p_{2n}** maximum continuous pressure - maximum working pressure, at which the pump can be operated without time limitation.
- 4) **p_{2max}** maximum pressure - maximum pressure permissible for a short time, max. 20 s.
- 5) **p₃** peak pressure - short-time pressure (fractions of a second) arising in case of a sudden change of the operating mode; any excess of this pressure during operation is impermissible.

Gear Pump / Size		GPO - 0,18 ...3,2 ccm
Volumetric efficiency	%	92 ÷ 98
Mechanical efficiency	%	85
Fluid temperature range (NBR)	°C (°F)	-20...80 (-4...176)
Viscosity range	mm ² /s (SUS)	20 ...80 (97 ...390), 1200 (5849) for cold start
Hydraulic fluid		Hydraulic oils of power classes (HL, HLP) to DIN 51524
Max. degree of fluid contamination for p ₂ ≤ 200 bar		Class 21/18/15 acc. to ISO 4406
Max. degree of fluid contamination for p ₂ ≥ 200 bar		Class 20/17/14 acc. to ISO 4406

Direction of rotation, reversible design

Determine direction of rotation by looking at the drive shaft.
The pump can be used only in the specified direction of rotation.

The pumps B codes (Bi-directional) have an external drainage located in the cover.

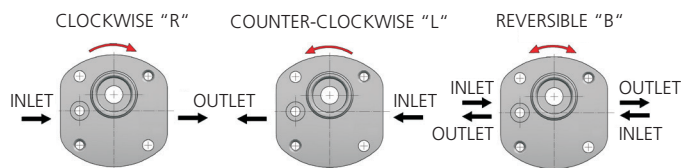

Pressure in this port:
min. -0,3 bar (-4.4 PSI)
max. +0,5 bar (+7.3 PSI)

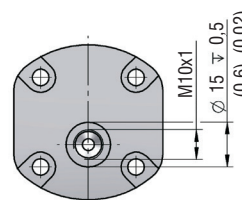

Ordering Code

GPO - [] - [] - [] - [] - [] - []

Gear pump serie 0

Displacement

- 0,18
- 0,25
- 0,32
- 0,36
- 0,40
- 0,50
- 0,63
- 0,70
- 0,80
- 1,00
- 1,25
- 1,50
- 2,00
- 2,50
- 3,20

Direction of rotation

- Counter clockwise: L
- Clockwise: R
- Bi-directional: B

Flange design

- Flange with two bolts M6 - centre ring Ø 22 mm (0,87 in): RA
- Flange with two bolts M5 - centre ring Ø 22 mm (0,87 in) screw pitch 32x32 mm (1,26x1,26 in): AA
- Flange with two bolts M5 - centre ring Ø 22 mm (0,87 in) screw pitch 30x32 mm (1,18x1,26 in): AB

Shaft seal

- No designation: standard
- 004: without shaft seal

Seals

- N: NBR

Inlet / Outlet port

- PA: Flange side port
- GA: BSP G1/4
- GB: BSP G3/8
- MA: M10x1

Ports orientation

- S
- F
- A
- C
- D

Shaft Type

- CA
- VA
- KA
- KB

Combination of Flanges and Shafts

Code	Drive shaft design	RA	AA	AB
CA	Taper 1:8 Woodruff key 2x2,6	●	●	●
VA	Cylindric Woodruff key 2x2,6	●	●	●
KA	Cross coupling	●	●	●
KB	Cross coupling	●	●	●

Ports orientation

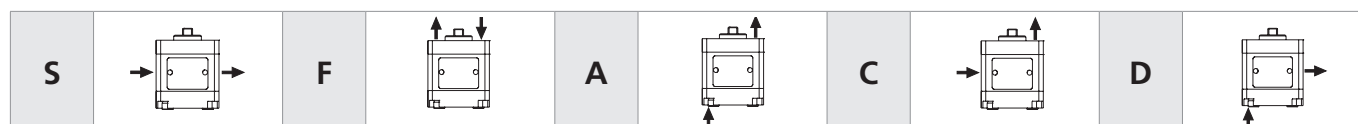

0,18 ccm

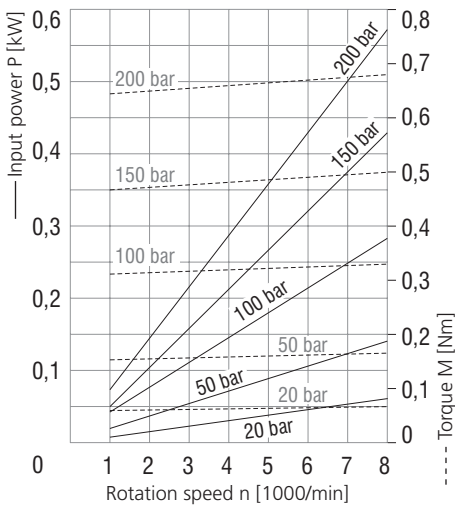

0,25 ccm

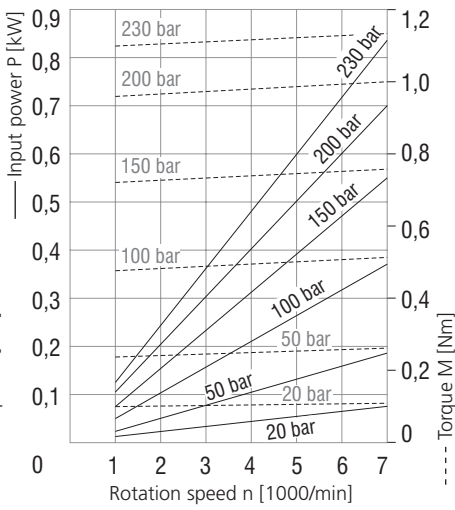

0,32 ccm

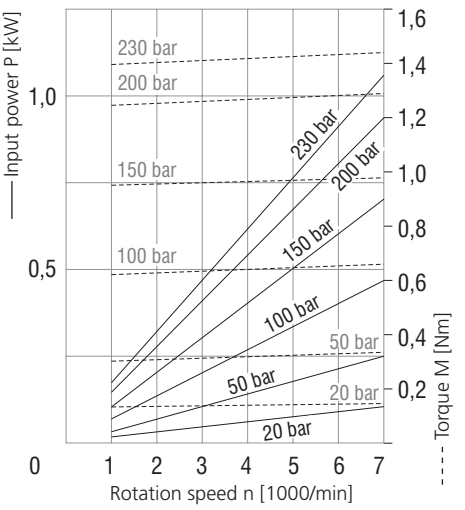

0,40 ccm

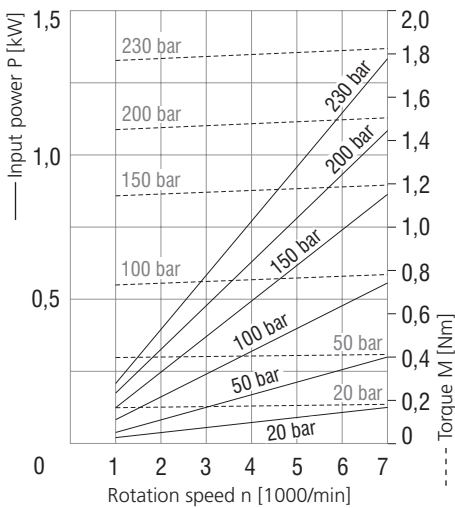

0,50 ccm

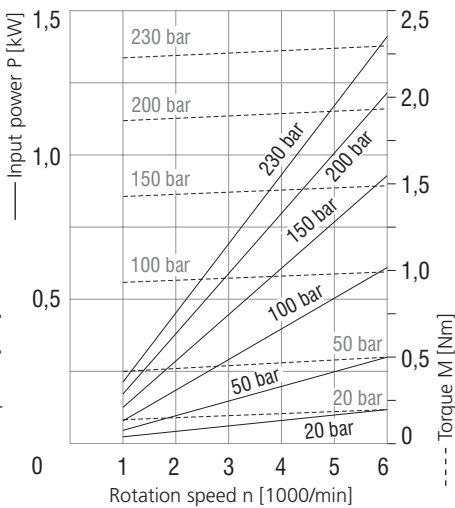

0,63 ccm

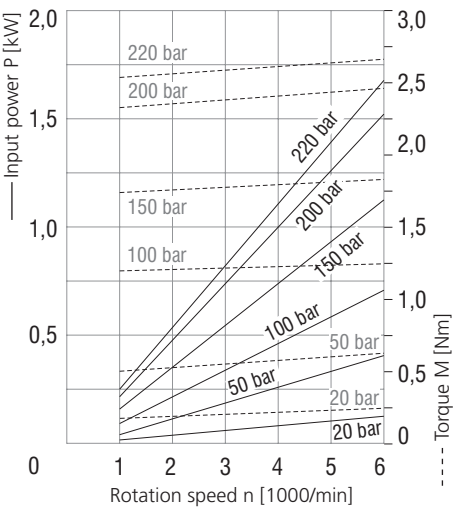

0,70 ccm

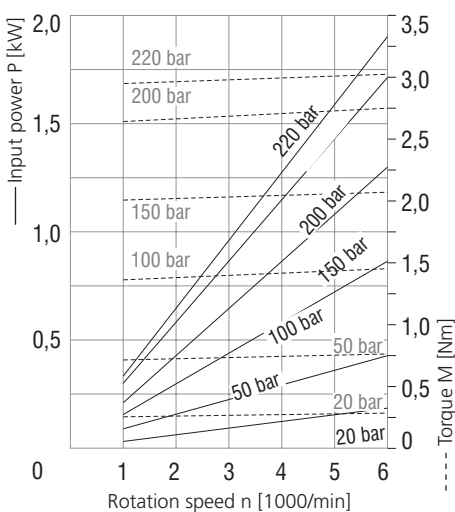

0,80 ccm

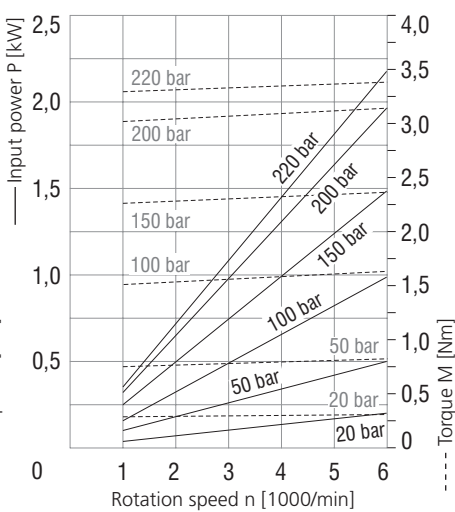

1,00 ccm

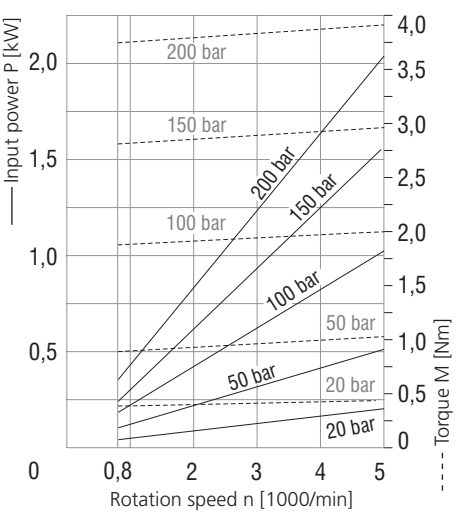

Characteristics measured at $v = 32 \text{ mm}^2/\text{s}$ (156 SUS)

1,25 ccm

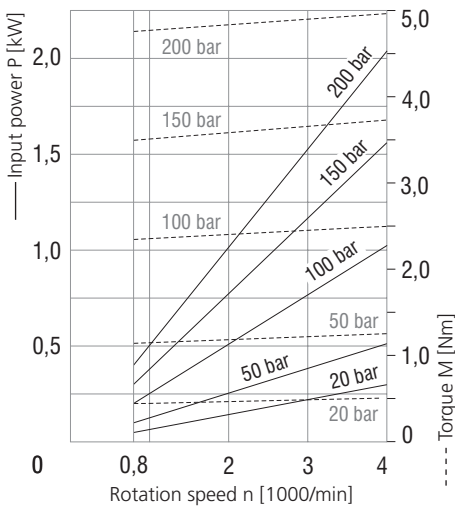

1,50 ccm

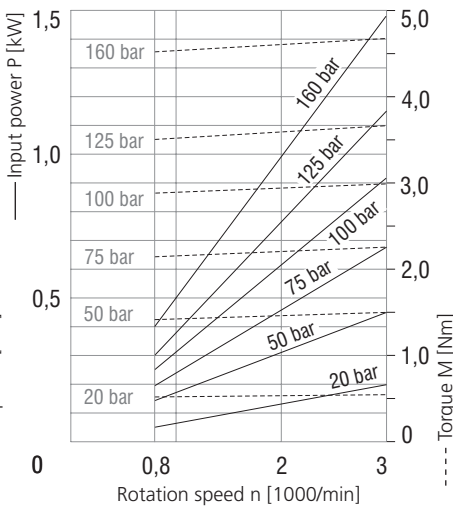

2,00 ccm

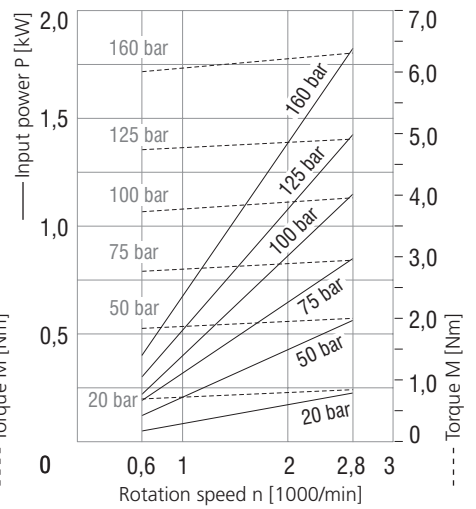

2,50 ccm

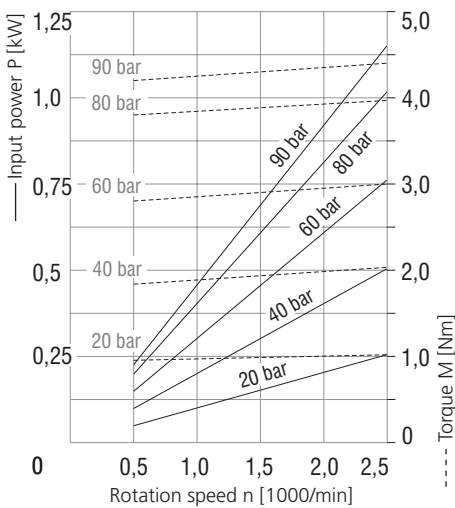

3,20 ccm

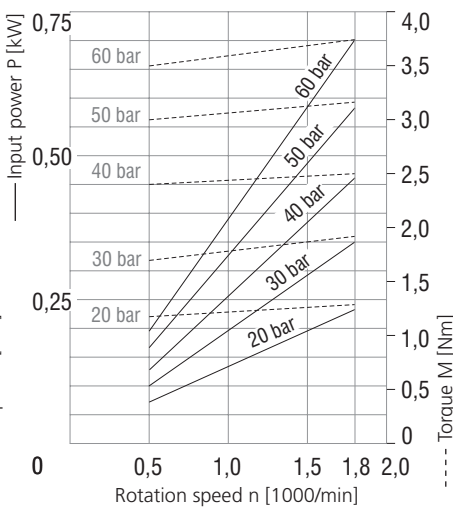

Flange design in millimeters (inches)

RA

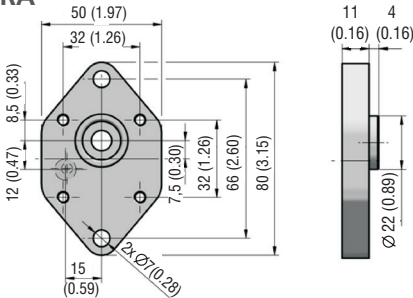

AA

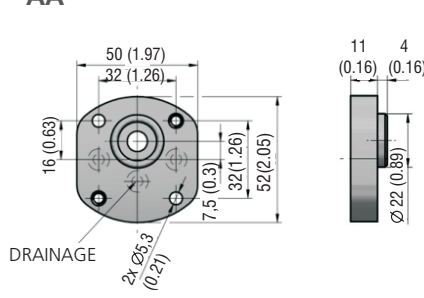

AB

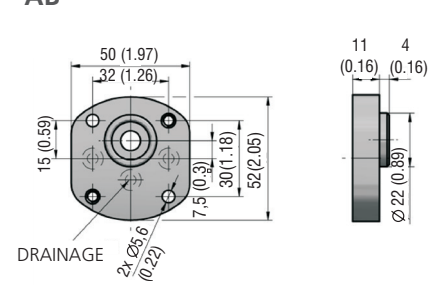

Shaft design in millimeters (inches)

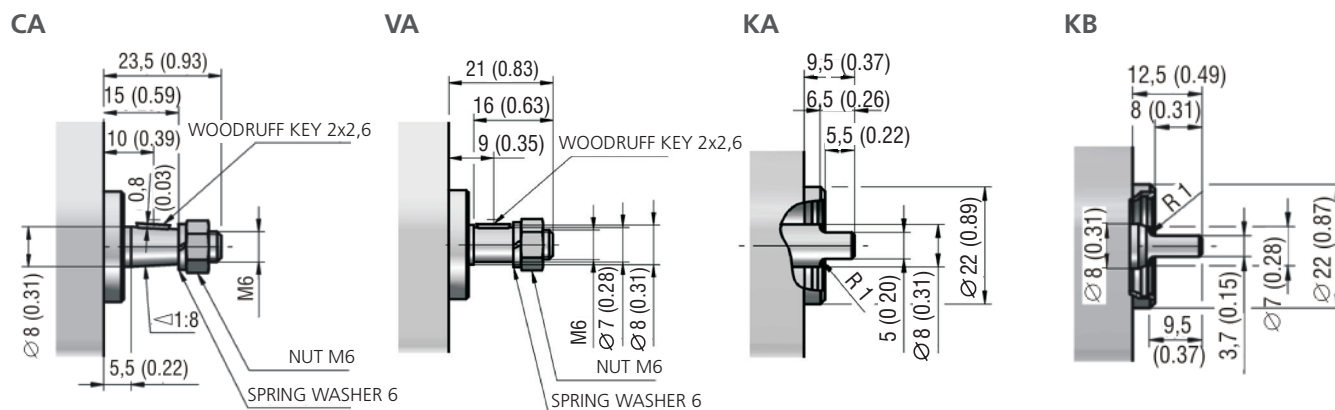

Ports design in millimeters (inches)

Dimensions of thread

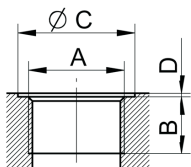

Displacement [cm ³ (in ³)]	Code	Inlet / Outlet			
		A	B	C	D
0,18-0,5 (0.01-0.03)	MA	M10x1	8 (0.31)	15 (0.59)	1 (0.04)
All	GA	G1/4	13 (0.51)	26 (1.02)	
	GB	G3/8		24 (0.94)	

Inlet / outlet

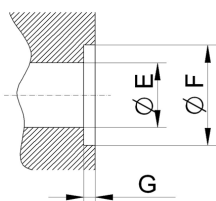

Displacement [cm ³ (in ³)]	Code	Inlet / Outlet		
		E	F	G
All	PA	4,5 (0.18)	8,9 (0.35)	1,1 (0.04)

Pump design in millimeters (inches)

GP0-*L-ABKA-AGBPA-N

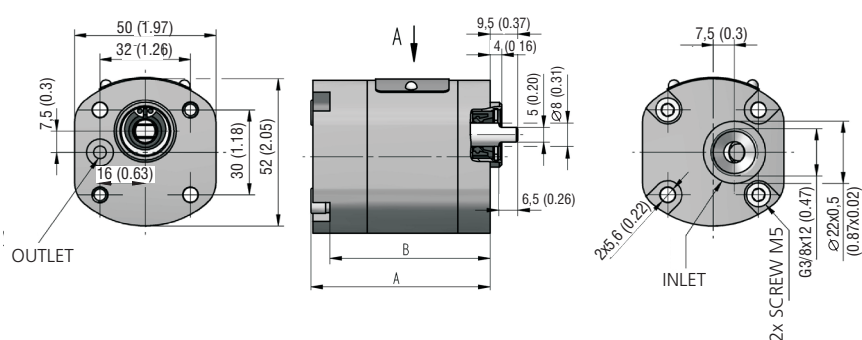

Displacement [cm ³ (in ³)/rev]	A	B	Displacement [cm ³ (in ³)/rev]	A	B
0,18 (0.01)	59,1 (2.33)	53,3 (2.10)	0,80 (0.05)	64,5 (2.54)	58,7 (2.31)
0,25 (0.02)	59,8 (2.35)	54,0 (2.13)	1,00 (0.06)	66,2 (2.61)	60,4 (2.38)
0,32 (0.02)	60,4 (2.38)	54,6 (2.15)	1,25 (0.08)	68,4 (2.69)	62,6 (2.46)
0,36 (0.02)	60,7 (2.39)	54,9 (2.16)	1,50 (0.09)	70,6 (2.78)	64,8 (2.55)
0,40 (0.02)	61,1 (2.41)	55,3 (2.18)	2,00 (0.12)	74,8 (2.94)	69 (2.72)
0,50 (0.03)	61,9 (2.44)	56,1 (2.21)	2,50 (0.15)	79,1 (3.11)	73,3 (2.89)
0,63 (0.04)	63,0 (2.48)	57,2 (2.25)	3,20 (0.20)	85,0 (3.35)	79,2 (3.12)
0,70 (0.04)	63,7 (2.51)	57,9 (2.28)			

Pump design in millimeters (inches)

GPO-*R(L)-RAVA-SGAGA-N

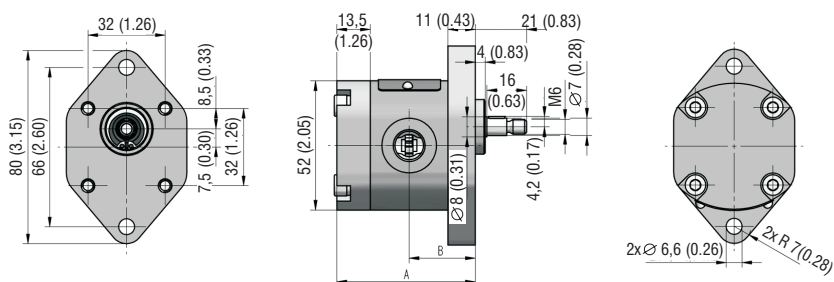

Displacement [cm ³ (in ³)/rev]	A	B	Displacement [cm ³ (in ³)/rev]	A	B
0,18 (0.01)	54,1 (2.13)	25,8 (1.02)	0,80 (0.05)	59,5 (2.34)	28,5 (1.12)
0,25 (0.02)	54,8 (2.16)	26,2 (1.03)	1,00 (0.06)	61,2 (2.41)	29,4 (1.16)
0,32 (0.02)	55,4 (2.18)	26,5 (1.04)	1,25 (0.08)	63,4 (2.50)	30,5 (1.20)
0,36 (0.02)	55,7 (2.19)	26,6 (1.05)	1,50 (0.09)	65,6 (2.58)	31,6 (1.24)
0,40 (0.02)	56,1 (2.21)	26,8 (1.06)	2,00 (0.12)	69,8 (2.75)	33,7 (1.33)
0,50 (0.03)	56,9 (2.24)	27,2 (1.07)	2,50 (0.15)	74,1 (2.92)	35,8 (1.41)
0,63 (0.04)	58,0 (2.28)	27,8 (1.09)	3,20 (0.20)	80,0 (3.15)	38,8 (1.53)
0,70 (0.04)	58,7 (2.31)	28,1 (1.11)			

GPO-*R(L)-RAKB-AGAPA-N

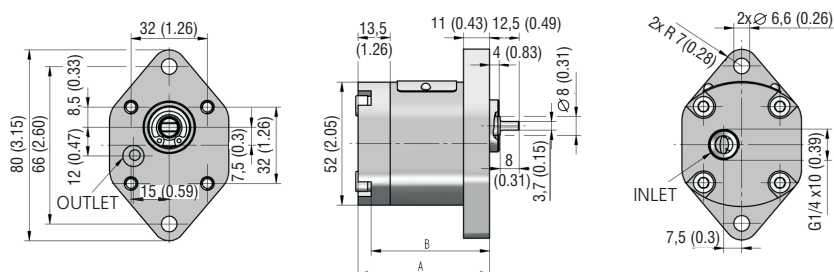

Displacement [cm ³ (in ³)/rev]	A	B	Displacement [cm ³ (in ³)/rev]	A	B
0,18 (0.01)	54,1 (2.13)	48,6 (1.91)	0,80 (0.05)	59,5 (2.34)	54,0 (2.13)
0,25 (0.02)	54,8 (2.16)	49,3 (1.94)	1,00 (0.06)	61,2 (2.41)	55,7 (2.19)
0,32 (0.02)	55,4 (2.18)	49,9 (1.96)	1,25 (0.08)	63,4 (2.50)	57,9 (2.28)
0,36 (0.02)	55,7 (2.19)	50,2 (1.98)	1,50 (0.09)	65,6 (2.58)	60,1 (2.37)
0,40 (0.02)	56,1 (2.21)	50,6 (1.99)	2,00 (0.12)	69,8 (2.75)	64,3 (2.53)
0,50 (0.03)	56,9 (2.24)	51,4 (2.02)	2,50 (0.15)	74,1 (2.92)	68,6 (2.70)
0,63 (0.04)	58,0 (2.28)	52,5 (2.07)	3,20 (0.20)	80,0 (3.15)	74,5 (2.93)
0,70 (0.04)	58,7 (2.31)	53,2 (2.09)			

GPO-*B-ABKA-FPAPA-N

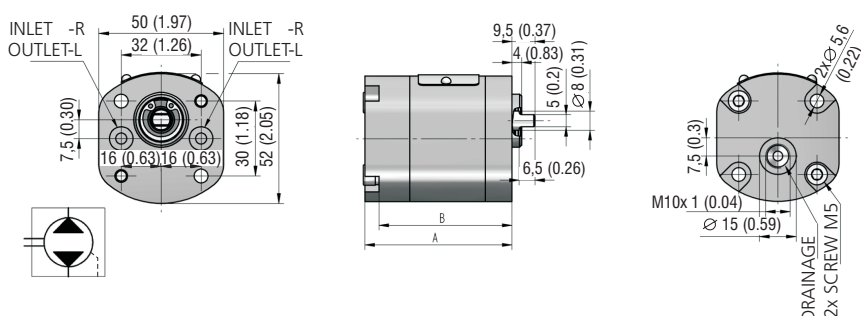

Displacement [cm ³ (in ³)/rev]	A	B	Displacement [cm ³ (in ³)/rev]	A	B
0,18 (0.01)	59,1 (2.33)	59,1 (2.33)	0,80 (0.05)	64,5 (2.54)	58,7 (2.31)
0,25 (0.02)	59,8 (2.35)	59,8 (2.35)	1,00 (0.06)	66,2 (2.61)	60,4 (2.38)
0,32 (0.02)	60,4 (2.38)	60,4 (2.38)	1,25 (0.08)	68,4 (2.69)	62,6 (2.46)
0,36 (0.02)	60,7 (2.39)	60,7 (2.39)	1,50 (0.09)	70,6 (2.78)	64,8 (2.55)
0,40 (0.02)	61,1 (2.41)	61,1 (2.41)	2,00 (0.12)	74,8 (2.94)	69,0 (2.72)
0,50 (0.03)	61,9 (2.44)	61,9 (2.44)	2,50 (0.15)	79,1 (3.11)	73,3 (2.89)
0,63 (0.04)	63,0 (2.48)	63,0 (2.48)	3,20 (0.20)	85,0 (3.35)	79,2 (3.12)
0,70 (0.04)	63,7 (2.51)	57,9 (2.28)			