

Kawasaki

K3V
K5V
SERIES

**Swash-plate Type Axial Piston Pumps
for Open Circuits in Industrial Vehicles**

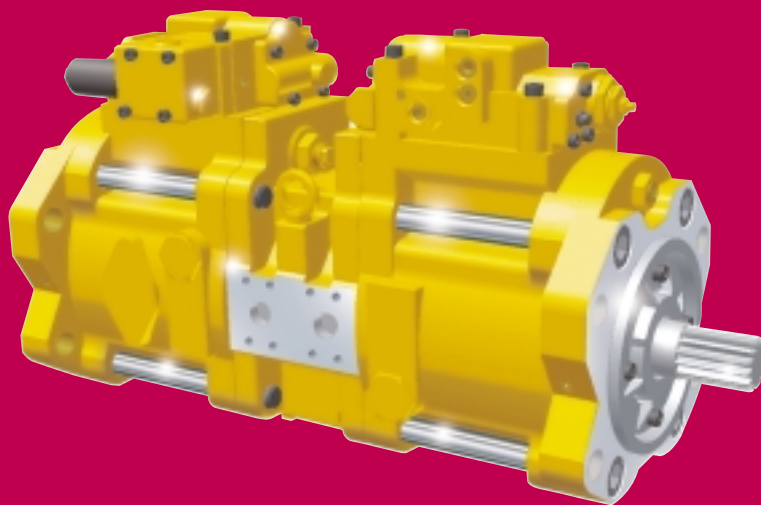

ON APPLICATION / USAGE OF THE PRODUCTS

Although our products are designed on the basis of our profound knowledge and long experience, and manufactured under the strict quality control system, the following must be taken into consideration in actual use.

1

The operating conditions of the products shown in this catalog vary depending upon each application. Therefore, the decision of the products' suitability to the system considered must be made by the designer of the hydraulic system and/or the person in charge of determining the specification after making analysis and conducting tests, if necessary. The study of the specification shall be done based on the latest catalog and technical documents, and the system must be composed taking into account situations regarding the possibility of machine failure.

2

Prior to use of the products, descriptions given in the SAFETY PRECAUTIONS must be observed for the proper use.

3

The technical information in this catalog represents typical characteristics and performance of the products, and is not guaranteed one.

4

In case the products are used in the following conditions or environments, please consult us prior to the use.

- ① Unspecified conditions or environments
- ② Use for atomic power, aviation, medical treatment, and/or food
- ③ Use likely to affect human beings or assets significantly or requiring particular safety

5





The information described in this catalog is subject to change without notice. For updated information, please consult our company.

SAFETY PRECAUTIONS





Before you use the product, you **MUST** read the operation or operators manual and **MUST** fully understand how to use the product.

To use the product safely, you **MUST** carefully read all Warnings and Cautions in this manual. You **MUST** also observe the related regulations and rules regarding safety.







■ Cautions related to operation

- ①  Use the safety equipment to avoid the injury when you operate the product.
CAUTION
- ②  Pay enough attention on handling method to avoid pinching hands or back problems that may be caused by heavy weight of the product or handling posture.
CAUTION
- ③  Do not step on the product, hit it, drop it or give strong outside force to it, as one of these actions may cause the failure of work, damage or oil leakage.
CAUTION
- ④  Wipe the oil on the product or floor off completely, as the oil creates slippery conditions that may result in dropping the product or injuring.
CAUTION





■ Warnings and Cautions related to installation and removal of the product

- ①  Installation, removal, plumbing, and wiring must be done by the certified person.
CAUTION
*CERTIFIED PERSON: a person who has enough knowledge like a person who is trained by Kawasaki's hydraulic school.
- ②  Make it sure that the power of the hydraulic power unit is turned off and that the electric motor or engine has completely stopped before starting installation or removal. You must also check the system pressure has dropped to zero.
WARNING
- ③  Turn off the power before starting wiring or other works related to the electric power, otherwise you may be stuck by an electric shock.
WARNING
- ④  Clean the threads and mounting surface completely, otherwise you may experience damages or oil leakage caused by insufficient tightening torque or broken seal.
CAUTION
- ⑤  Use the specified bolts and keep the specified tightening torque when you install the product. Usage of unauthorized bolts, lack of torque or excess of torque may create problems such as failure of work, damage and oil leakage.
CAUTION

■ Warnings and Cautions for operation

- ①  Never use the product not equipped with anti-explosion protection in the circumstances of possible explosion or combustion.
DANGER
- ②  Shield the rotating part such as motor shaft and pump shaft to avoid injuries caused by being caught of fingers or cloths.
WARNING
- ③  Stop the operation immediately if you find something wrong such as unusual noise, oil leakage or smoke, and fix it properly. If you continue operating, you may encounter damage, fire or injury.
WARNING
- ④  Make it sure that plumbing and wiring are correct and all the connection is tightened correctly before you start operating, especially if it is the first run.
CAUTION
- ⑤  Use the product under the specification mentioned in the catalog, drawings and specification sheet.
CAUTION
- ⑥  Keep your body off the product during the operations as it may become hot and burn your body.
CAUTION
- ⑦  Use the proper hydraulic oil, and maintain the contamination in the recommended level, otherwise it may not work or be damaged.
CAUTION

■ Cautions related to maintenance

- ①  Never modify the product without approval of Kawasaki.
CAUTION
- ②  Do not disassemble and assemble without approval by Kawasaki. It may cause troubles and failure, or it may not work as specified. If it is necessary by all means to disassemble and assemble, it must be done by an authorized person.
CAUTION
- ③  Keep the product from dust and rust by paying attention to the surrounding temperature and humidity when you transport or store the product.
CAUTION
- ④  Replacing the seals may be required if you use the product after long time storage.
CAUTION

Out of a Wide Variety of Our Swash Plate Type Axial Piston Pumps, We Introduce below Those Most Suitable for Construction Machines with Open Circuits.

KPM Swash Plate Type Axial Piston Pumps Programs for Industrial Vehicles

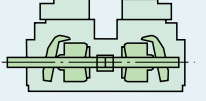
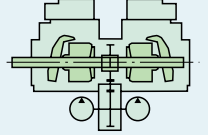
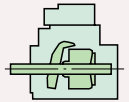
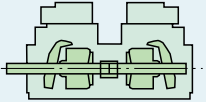
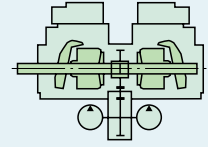
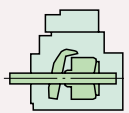
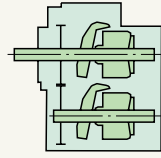
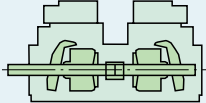
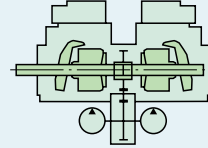
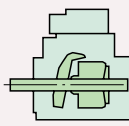
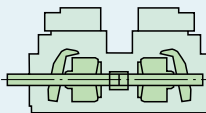
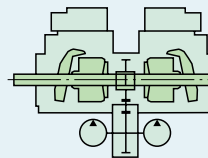
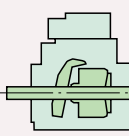
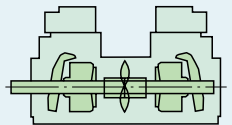
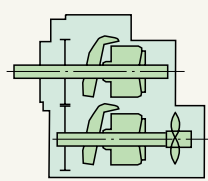
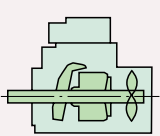
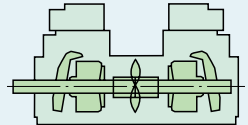
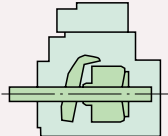
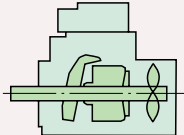
Displacement	Double pump (Tandem type)	Double pump (Parallel type)	Single pump
60 cm ³	<ul style="list-style-type: none"> •K3V63DT •K5V80DT 	<ul style="list-style-type: none"> •K3V63DTP •K5V80DTP 	<ul style="list-style-type: none"> •K3V63S •K5V80S 
80			
110	<ul style="list-style-type: none"> •K3V112DT •K5V140DT 	<ul style="list-style-type: none"> •K3V112DTP •K5V140DTP 	<ul style="list-style-type: none"> •K3V112S •K5V140S 
140		<ul style="list-style-type: none"> •K3V112DP •K5V140DP 	
200	<ul style="list-style-type: none"> •K3V140DT 	<ul style="list-style-type: none"> •K3V140DTP 	<ul style="list-style-type: none"> •K3V140S 
280	<ul style="list-style-type: none"> •K5V200DT 	<ul style="list-style-type: none"> •K5V200DTP 	<ul style="list-style-type: none"> •K5V200S 
	<ul style="list-style-type: none"> •K5V200DTH 	<ul style="list-style-type: none"> •K5V200DPH 	<ul style="list-style-type: none"> •K5V200SH 
	<ul style="list-style-type: none"> •K3V280DTH 		<ul style="list-style-type: none"> •K3V280S 
			<ul style="list-style-type: none"> •K3V280SH 

A Thorough Function Design Enabled Such Attractive Features

1. High Power Density

A lighter and more compact machine with higher pressure rating and increased power density (output power/mass) was obtained by adopting a half log type swash plate.

In particular, the double pump with its tandem arrangement, has eliminated a power divider, has an increased transmission efficiency, and is lighter.

2. High Efficiency and Large Self-Priming Capability

The spherical valve plate and improved hydraulic balance provide stable cylinder rotation, thus achieving high efficiency even in a low-pressure and low-speed operating range.

3. Long Life

A long life is obtained by adopting main bearings of large capacity and the piston-return mechanism that compensates for the wear of the shoe.

4. Low Noise

Even less noise has been achieved because of the optimum design of the valve plate and the casing rigidity.

5. Wide Range of Controls

The pump can be controlled in various kinds of control methods and is capable of responding to either mechanical, hydraulic or electrical input.

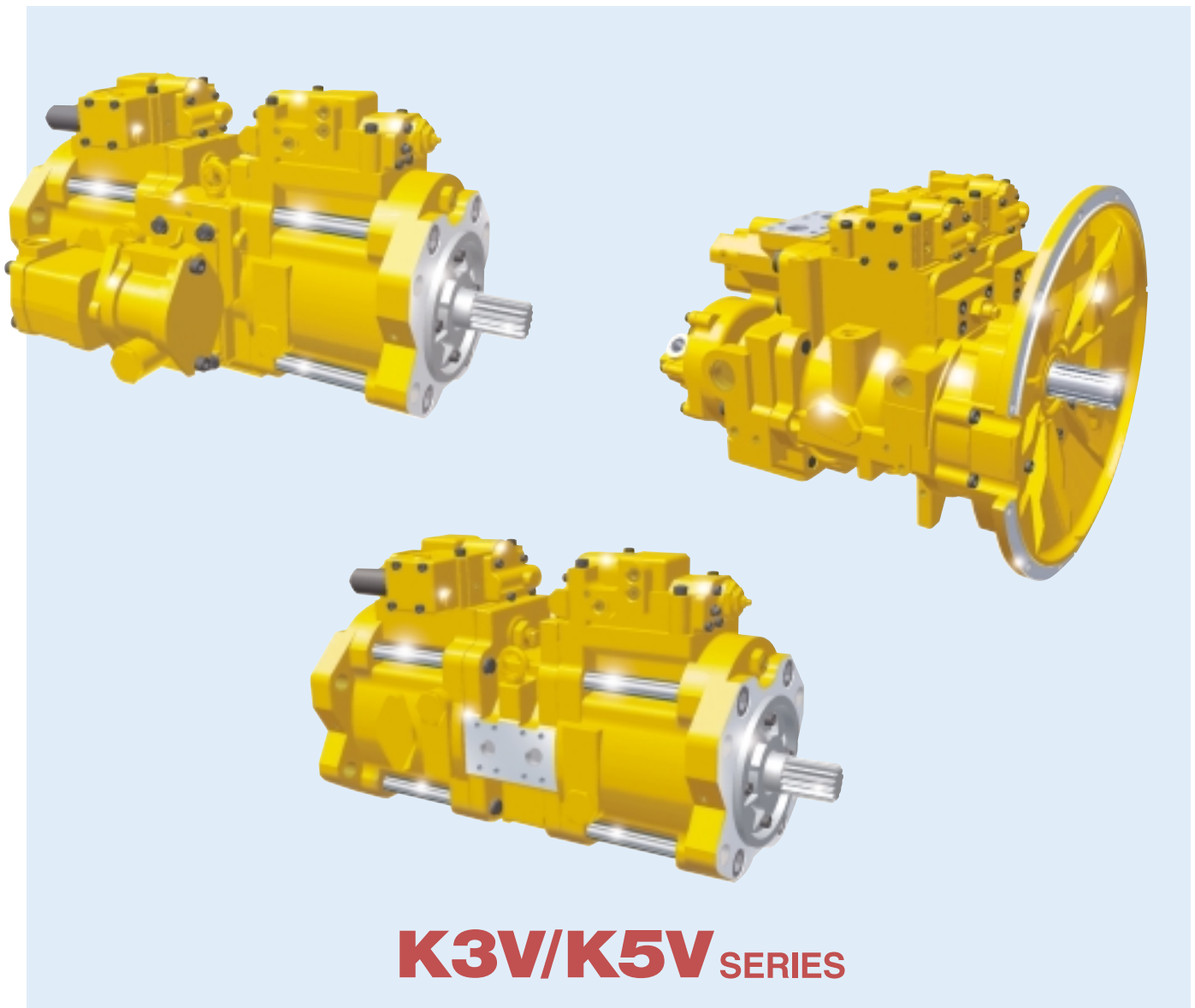

K3V SERIES

The N series pump, which was used widely as a piston pump especially for construction machines, has been modified to the K3V series, meeting the present-day requirements. This pump has optimum function design and is provided with further improved power density, efficiency, and reliability, attained from our many years of experiences with the NV series.

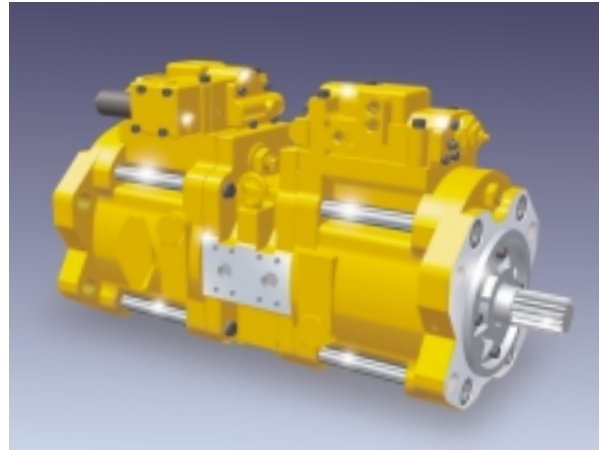

ORDERING CODE

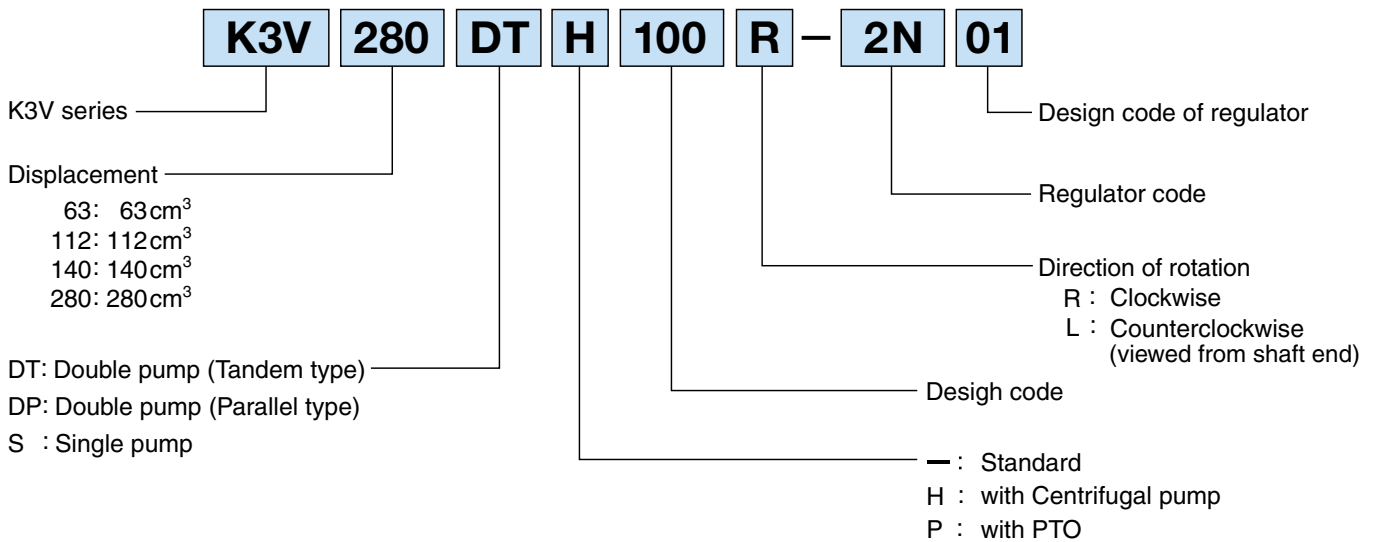

SPECIFICATIONS

1MPa = 10.197kgf/cm²
 1N·m = 0.10197kgf·m

Size		63	112	140	280
Displacement (cm ³)		63	112	140	280
Pressure (MPa)	*1 Rated	34.3			
	Peak	39.2			
Speed (min ⁻¹)	*2 Max. for self priming	2,650	2,360	2,150	1,600 (*4) (2,000)
	*3 Max.	3,250	2,700	2,500	2,000
Max. input torque of tandem pump (N·m)		343	588	1,120	1,950
Max. input torque of attached gear pump with PTO (N·m)		125		294	—
Mass (kg)	Single	48	68	86	140
	Tandem	81	125	160	270
Hydraulic fluid	Type	*5 Antiwear hydraulic fluid			
	Oil temperature range	-20 ~ +95 °C			
	Oil viscosity range	10 ~ 1,000 mm ² /S (cSt)			
	Filtration	Suction line	80 ~ 150 mesh		
Return line		nominal 10 micron meter			

- *1. Pressure to which guarantee of performance, functions or service life is applied. Durability is unlimited (except for the bearing life).
- *2. At max. displacement. In case of engine driving, max. idling speed should be below this value. This suction pressure should be -0.01 MPa and above.
- *3. Suction pressure should be above 0.1MPa.
- *4. Max. speed with centrifugal pump
- *5. When other kinds of fluid would be used, please consult with us.

K5V SERIES

With new technology the K5V series has enabled increased power density.

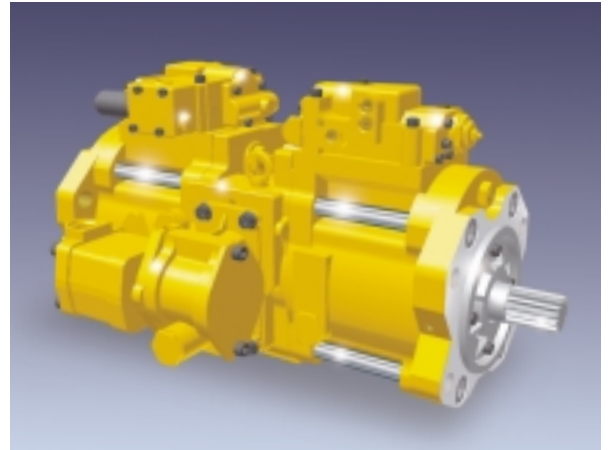
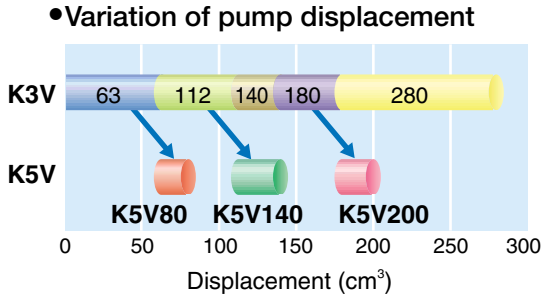

ORDERING CODE

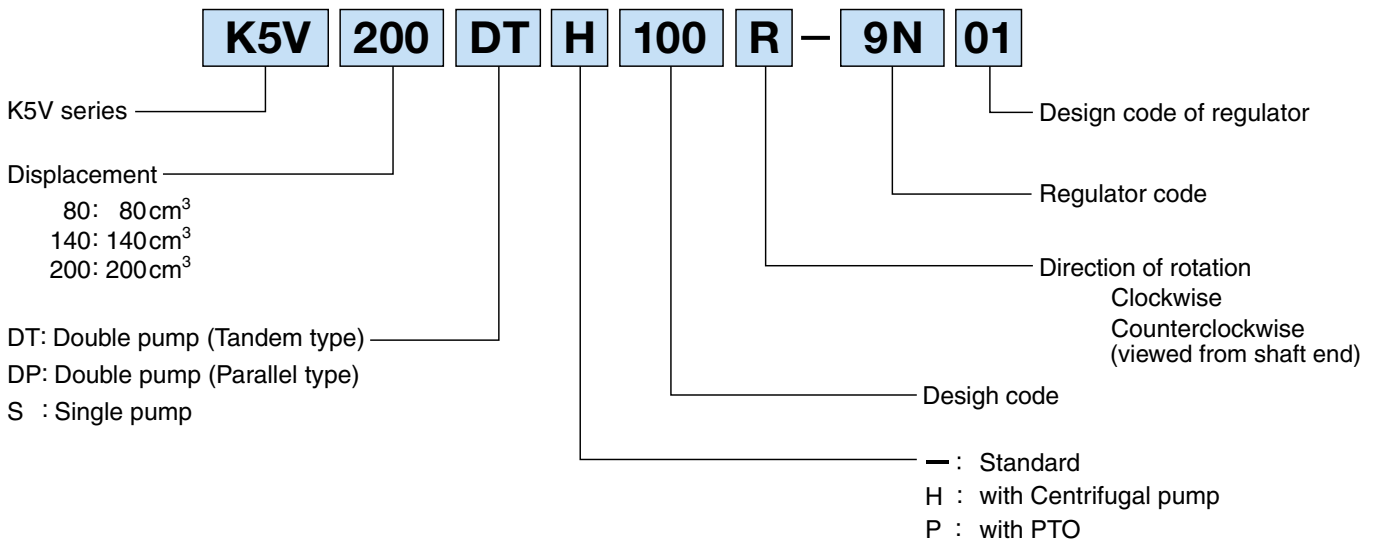

SPECIFICATIONS

1MPa=10.197kgf/cm²
1N·m=0.10197kgf·m

Size	80	140	200
Displacement (cm ³)	80	140	200
Pressure (MPa)	*1 Rated		
	Peak		
Speed (min ⁻¹)	*2 Max. for self priming		1,900 (2,200)*4
	*3 Max.		2,200
Max. input torque of tandem pump (N·m)	529	843	1,120
Max. input torque of attached gear pump with PTO (N·m)	125		294
Mass (kg)	Single	48	68
	Tandem	81	125
Hydraulic fluid	Type	*5 Antiwear hydraulic fluid	
	Oil temperature range	-20 ~ +95 °C	
	Oil viscosity range	10 ~ 1,000 mm ² /S (cSt)	
	Filtration	Suction line	80 ~ 150 mesh
Return line		nominal 10 micron meter	

*1. Pressure to which guarantee of performance, functions or service life is applied. Durability is unlimited (except for the bearing life).

*2. At max. displacement. In case of engine driving, max. idling speed should be below this value. This suction pressure should be -0.0 1MPa and above.

*3. Suction pressure should be above 0.1MPa.

*4. Max. speed with centrifugal pump

*5. When other kinds of fluid would be used, please consult with us.

•Horsepower Control

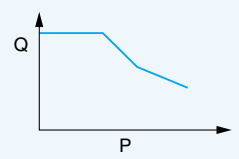
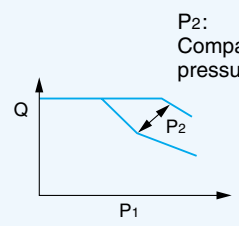
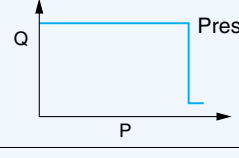
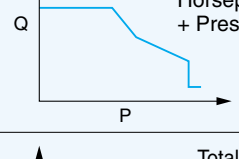
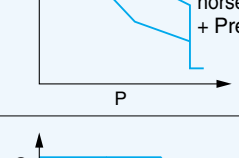
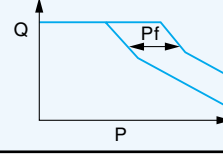
Code	Control type	Control curve	Function & features
1	Constant horsepower control		According to the rise of delivery pressure of a pump, the tilting angle of the pump is automatically decreased, and the constant torque control is achieved.
2	Total horsepower control		1. According to the rise of delivery pressure of a pump, the tilting angle of the pump is automatically decreased, and the constant torque control is achieved. (compensation control) 2. The total horsepower control can be achieved by decreasing the horsepower of a pump depending upon the pressure of its companion pump.
4	High pressure cut-off		If the pressure rises above the set value, the pump outlet flow is automatically decreased by the pressure cut-off control.
5			
6			
9	Variable horsepower control		Variable horsepower control can be obtained by supplying pilot pressure or electric current.

•Flow Control

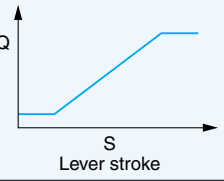
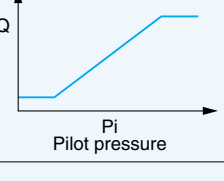
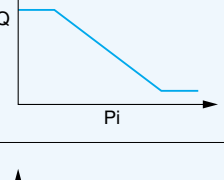
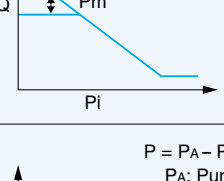
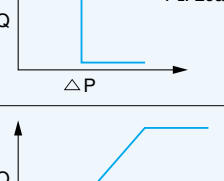
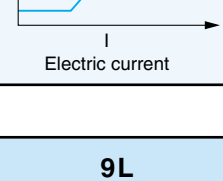
Code	Control type	Control curve	Function & features
M	Manual flow control		With the manual control, the outlet flow can be steplessly controlled.
P	Positive flow control		Positive flow control can be carried out by using the pilot pressure.
N	Negative flow control		Negative flow control can be carried out by using the pilot pressure.
C	2-stage max. flow control		Two-stage max. flow control can be obtained by supplying external pilot pressure. (only in negative flow control)
L	Load sensing control		Load sensing control can be obtained.
E	Electric flow control		With the electric current, the outlet flow can be controlled.

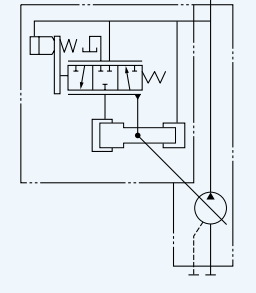
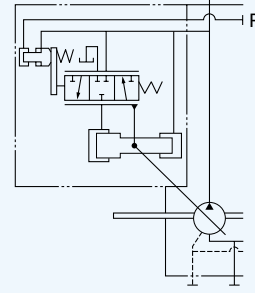
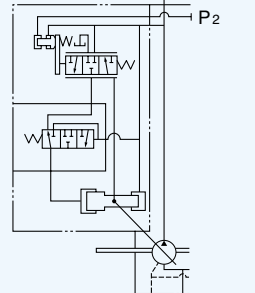
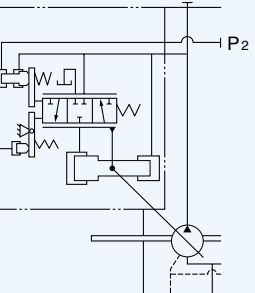
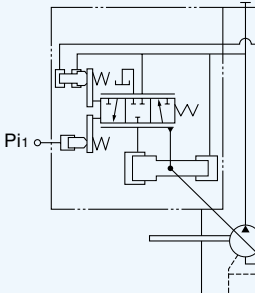
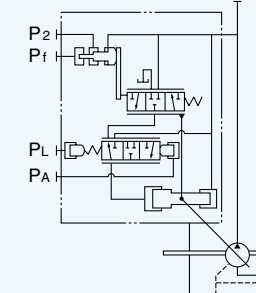
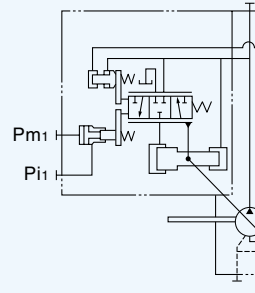
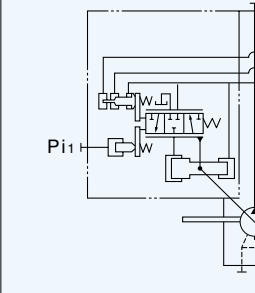
Code No.	10	20	60	2P	2N	9L	2C	9N
Control type	Constant horsepower control	Total horsepower control	Total horsepower control + High-pressure cut-off	Positive flow control + Total horsepower control	Negative flow control + Total horsepower control	Load sensing control + Total horsepower control + Variable horsepower control	Negative flow control + Total horsepower control + Two-stage max. flow control	Negative flow control + Total horsepower control + Variable horsepower control
Circuit diagram								

Flow control and Horsepower control can be combined with each other. Examples of applied circuits are shown above. Please consult us about other kinds of control, if necessary.

DIMENSIONS

• Tandem Type

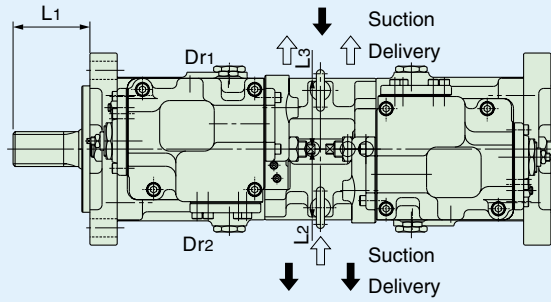

Direction of rotation
 ↑ : Clockwise
 ↓ : Counterclockwise
 (Viewed from shaft end)

Use Dr1 or Dr2 port for case drain.

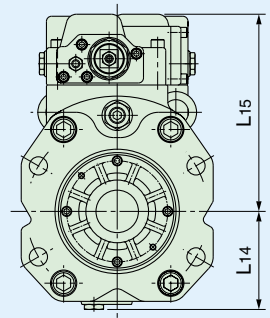
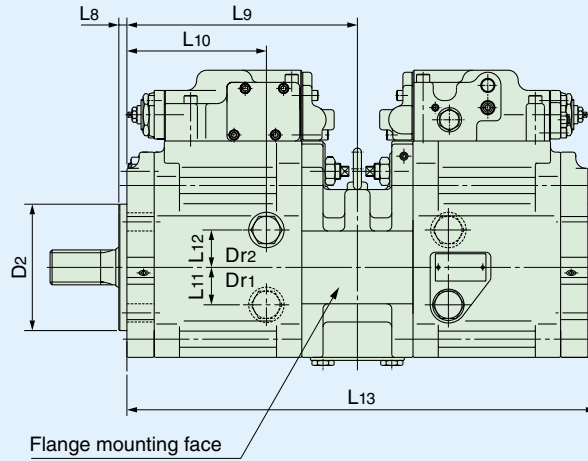
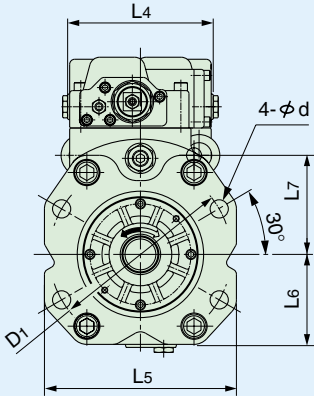

• Tandem Type (with PTO)

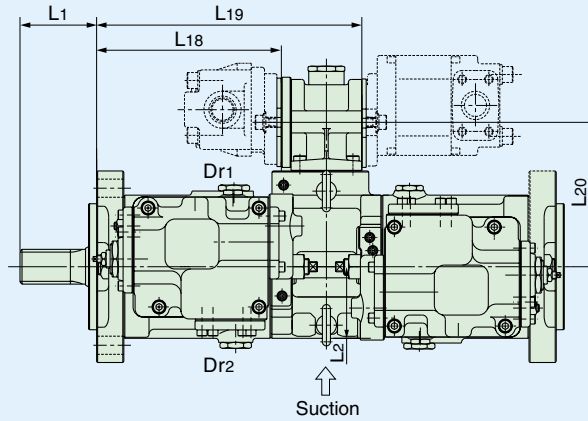

Dimensions of PTO unit

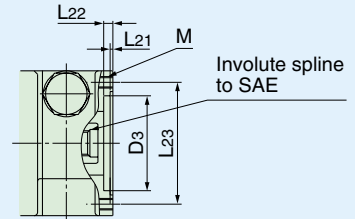

• Involute spline to SAE

	Number of teeth	10	13
Cutter	Root form	Flat root	
	Diametral pitch	16/32	
	Pressure angle	30°	
	Type of fit	Side fit	
	Rule	SAE	

Use Dr1 or Dr2 port for case drain.

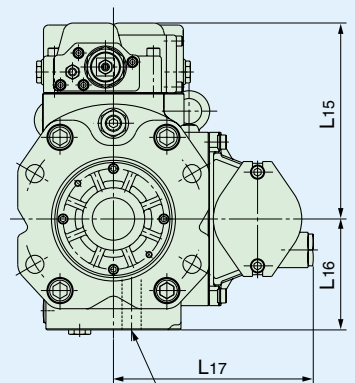
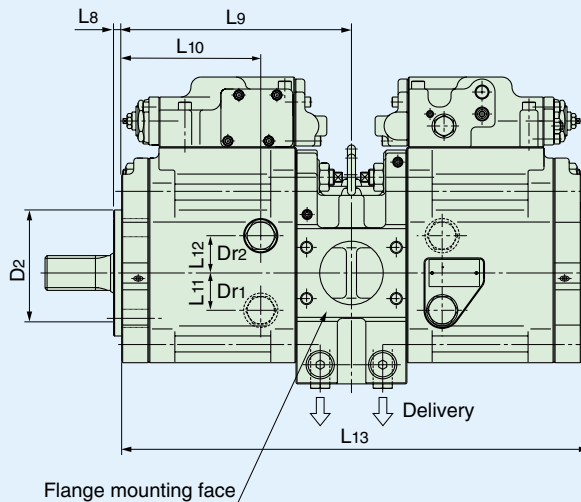
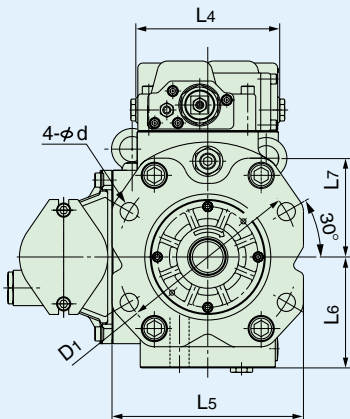

• Dimensions

Size	D1	D2	D3	d	L1	L2	L3	L4	L5	L6	L7	L8	L9	L10	L11	L12	L13	L14	L15
K3V63	180	125	82.55	18	76	70	70	142	190	89	98	8	228	138	37	37	464	97	195
K3V112	224	160	82.55	22	78	80	80	142	234	100	110	8	265	167	41	41	538	109	220
K3V140	250	180	101.6	22	93	92	92	142	256	112	123	8	305	190	53	53	618	121	245
K3V280	300	200	—	26	115	150	125	142	300	127	140	8	356	203	70	70	792	150	286
K5V80	180	125	82.55	18	76	70	70	142	190	89	98	8	228	138	37	37	464	97	195
K5V140	224	160	82.55	22	78	80	80	142	234	100	110	8	265	167	41	41	538	109	220
K5V200	250	180	101.6	22	93	92	92	142	256	112	123	8	305	190	53	53	618	121	245

(mm)

Size	L16	L17	L18	L19	L20	L21	L22	L23	M
K3V63	110	213	177	268	150	2.4	8	106	2-M10-25
K3V112	110	213	214	305	150	2.4	8	106	2-M10-25
K3V140	122	292	257	361	200	2.4	15	127	4-M12-22
K5V80	110	213	177	268	150	2.4	8	106	2-M10-25
K5V140	110	213	214	305	150	2.4	8	106	2-M10-25
K5V200	122	292	257	361	200	2.4	15	127	4-M12-22

• Dimensions of shaft end

Size	Spec.	No. of teeth	Pitch circle dia (mm)	Pressure angle	Module	Rule
K3V63		14	29.6	30°	12/24	SAE
K3V112		14	35.0	20°	2.5	JIS B 1603
K3V140		17	42.5	20°	2.5	JIS B 1603
K3V280		18	54.0	20°	3.0	JIS B 1603
K5V80		12	30.0	20°	2.5	JIS B 1603
K5V140		17	42.5	20°	2.5	JIS B 1603
K5V200		17	42.5	20°	2.5	JIS B 1603

• Flange mounting face for Suction port (SAE Rule) (mm)

Size	a	b	c	d-Screw depth
K3V63	50.8	88.9	∅60	M12-18
K3V112	50.8	88.9	∅60	M12-18
K3V140	61.9	106.4	∅76	M16-24
K3V280	69.8	120.7	∅89	M16-24
K5V80	50.8	88.9	∅60	M12-18
K5V140	50.8	88.9	∅60	M12-18
K5V200	61.9	106.4	∅76	M16-24

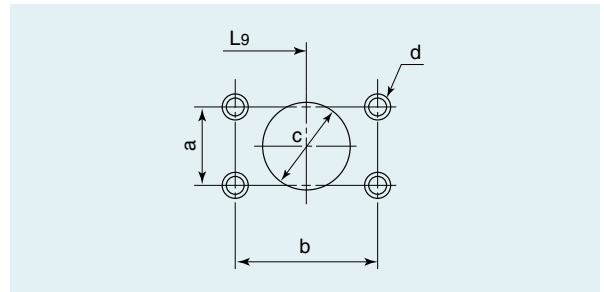

• Flange mounting face for Delivery port (SAE Rule) (mm)

Size	a	b	c	d	e-Screw depth
K3V63	23.8	50.8	∅19	31.0	M10-16
K3V112	23.8	50.8	∅19	31.0	M10-16
K3V140	27.8	57.2	∅25	37.5	M12-22
K3V280	31.8	66.7	∅32	61.5	M12-20
K5V80	23.8	50.8	∅19	31.0	M10-16
K5V140	23.8	50.8	∅19	31.0	M10-16
K5V200	27.8	57.2	∅25	37.5	M12-22

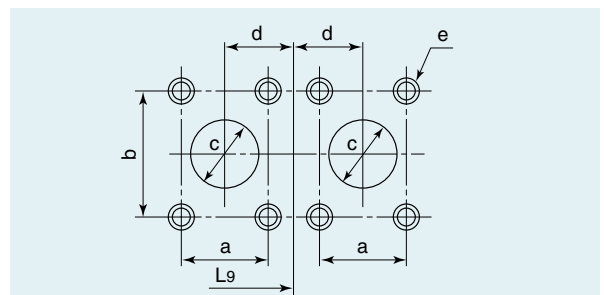

• Drain port (Rule: JIS B 2351) (mm)

Size	a	b	c	d
K3V63	G 1/2	22.6	2.5	19
K3V112	G 3/4	30.8	3.5	20
K3V140	G 3/4	30.8	3.5	23
K3V280	G 3/4	30.8	3.5	23
K5V80	G 1/2	22.6	2.5	19
K5V140	G 3/4	30.8	3.5	20
K5V200	G 3/4	30.8	3.5	23

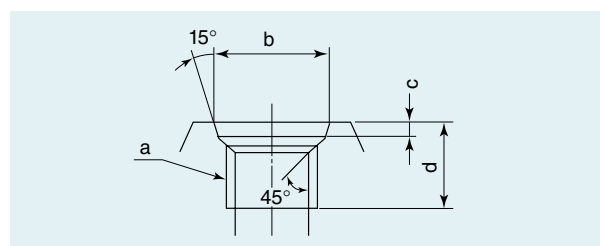

DIMENSIONS

• Parallel Type

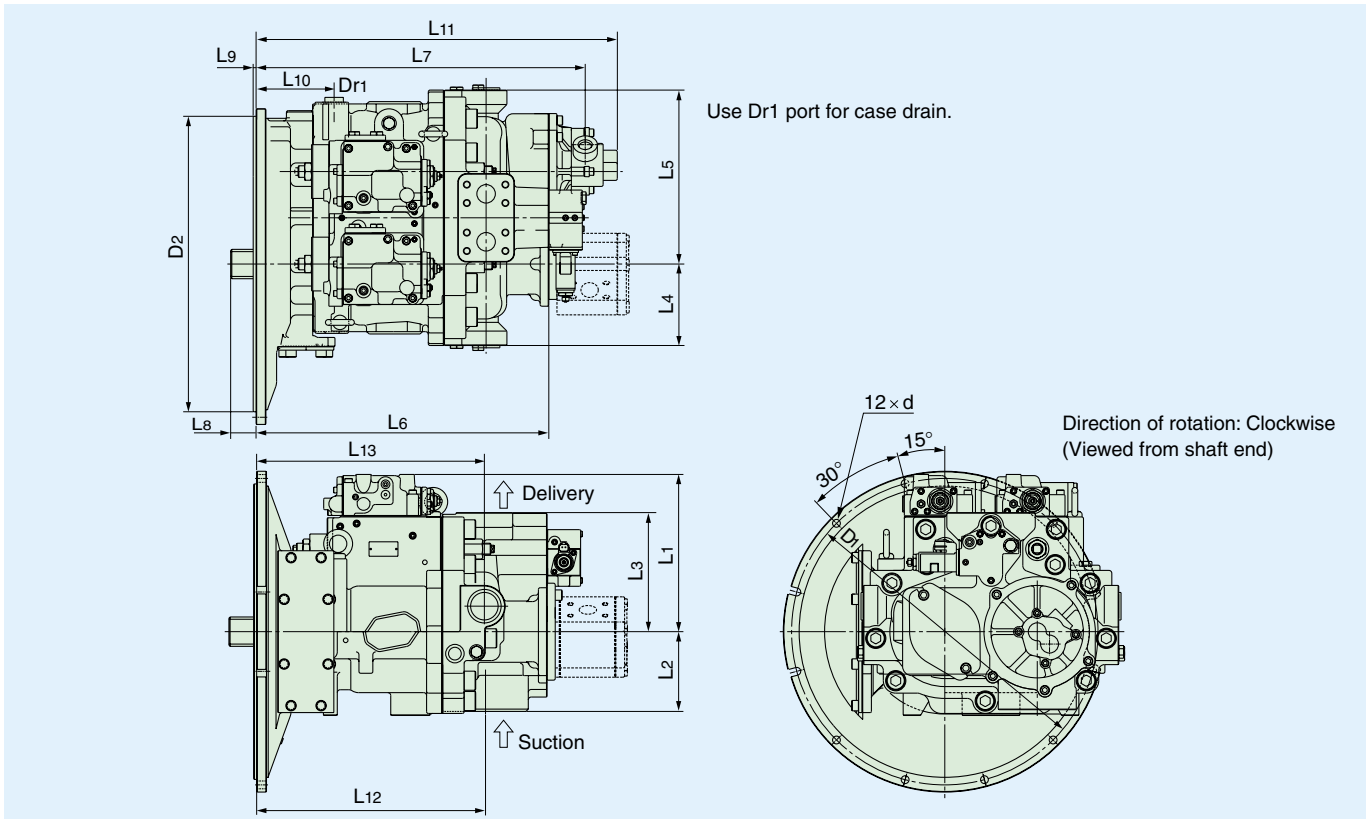

• Dimensions

Size	D1	D2	d	L1	L2	L3	L4	L5	L6	L7	L8	L9	L10	L11	L12	L13
K3V112	429	410	11	235	113	163	111	256	428	493	34	5	148	522	391	385
K5V140	429	410	11	235	113	163	111	256	428	493	34	5	148	522	391	385
K5V200	530	511	14	272	138	206	141	301	507	570	34	5	135	625	400	398

• Dimensions of shaft end

Size	Spec.	No. of teeth	Pitch circle dia (mm)	Pressure angle	Module	Rule
K3V112		14	35.0	20°	2.5	JIS B 1603
K5V140		17	42.5	20°	2.5	JIS B 1603
K5V200		15	47.6	30°	8/16	ANSI

• Flange mounting face for Suction port (SAE Rule) (mm)

Size	a	b	c	d—Screw depth
K3V112	50.8	88.9	φ60	M12—18
K5V140	50.8	88.9	φ60	M12—18
K5V200	69.9	120.7	φ83	M16—24

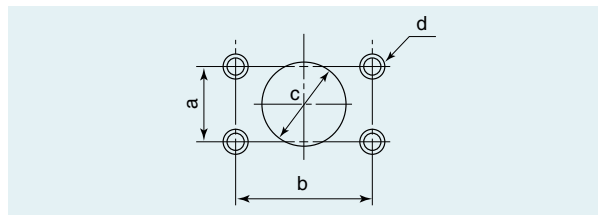

• Flange mounting face for Delivery port (SAE Rule) (mm)

Size	a	b	c	d	e—Screw depth
K3V112	23.8	50.8	φ19	34.0	M10—16
K5V140	23.8	50.8	φ19	34.0	M10—16
K5V200	31.8	66.7	φ32	41.5	M12—22

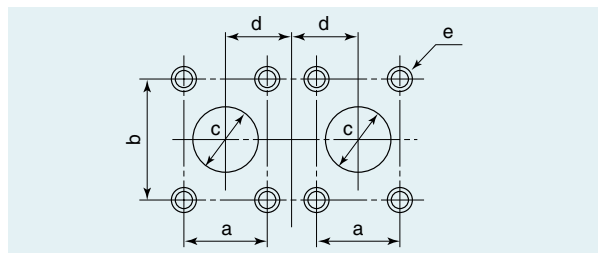

• Drain port (Rule: JIS B 2351) (mm)

Size	a	b	c	d
K3V112	G 3/4	30.8	3.5	20
K5V140	G 3/4	30.8	3.5	20
K5V200	G 3/4	30.8	3.5	23

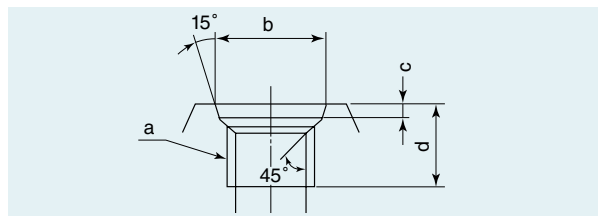

• Single Type

for K5V200S

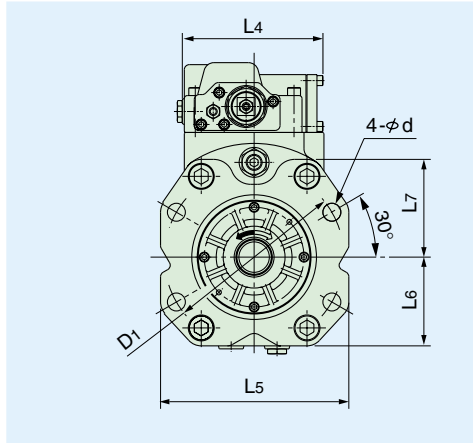
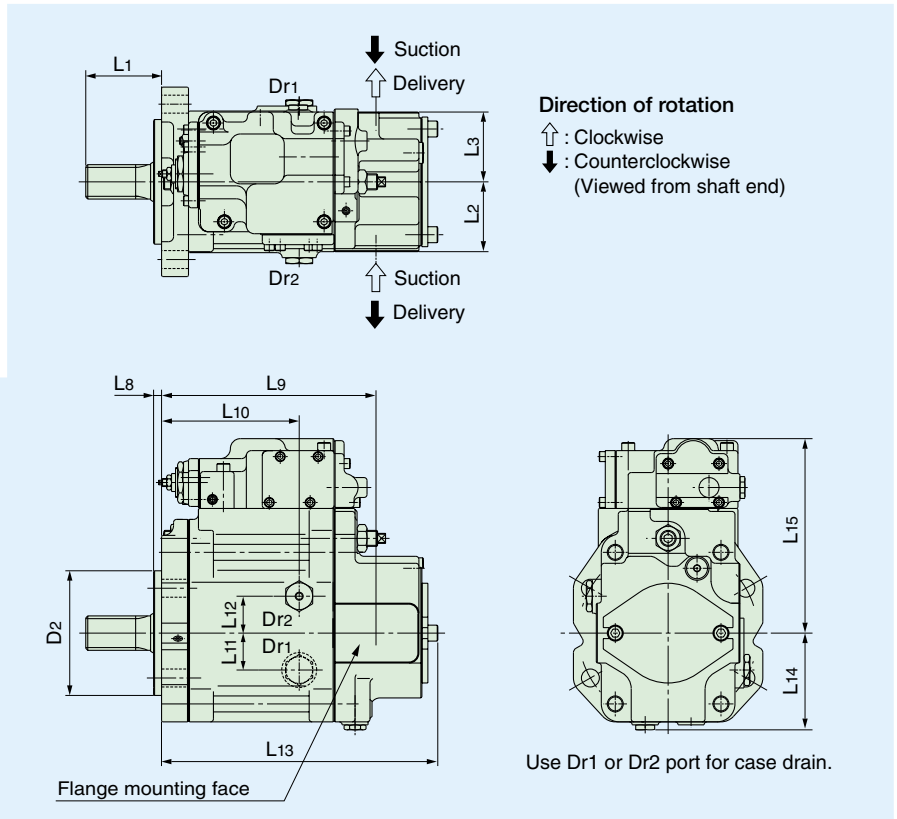
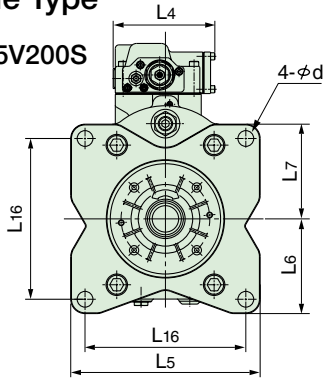

Use Dr1 or Dr2 port for case drain.

• Dimensions

(mm)

Size	D1	D2	d	L1	L2	L3	L4	L5	L6	L7	L8	L9	L10	L11	L12	L13	L14	L15	L16
K3V63	180	125	18	76	70	70	142	190	89	98	8	210	138	37	37	277	89	195	—
K3V112	224	160	22	78	80	80	142	234	100	110	8	250	167	41	41	309	109	220	—
K3V140	250	180	22	93	92	92	142	256	112	123	8	292	190	53	53	366	121	245	—
K3V280	300	200	22	115	150	125	142	300	127	140	8	343	203	70	70	433	135	286	—
K5V80	180	125	18	76	70	70	142	190	89	98	8	210	138	37	37	277	89	195	—
K5V140	224	160	22	78	92	92	142	234	100	110	8	264	167	41	41	338	109	220	—
K5V200	—	165	22	75	92	92	142	265	132	132	16	300	190	53	53	389	121	245	225

• Dimensions of shaft end

Size	Spec.	No. of teeth	Pitch circle dia (mm)	Pressure angle	Module	Rule
K3V63		14	29.6	30°	12/24	SAE
K3V112		14	35.0	20°	2.5	JIS B 1603
K3V140		17	42.5	20°	2.5	JIS B 1603
K3V280		18	54.0	20°	3.0	JIS B 1603
K5V80		12	30.0	20°	2.5	JIS B 1603
K5V140		17	42.5	20°	2.5	JIS B 1603
K5V200		13	41.3	30°	8/16	SAE

• Flange mounting face for Suction port (SAE Rule) (mm)

Size	a	b	c	d-Screw depth
K3V63	35.7	69.9	φ38	M12-18
K3V112	30.2	58.7	φ38	M12-18
K3V140	50.8	88.9	φ60	M12-18
K3V280	69.9	120.7	φ80	M12-20
K5V80	35.7	69.9	φ38	M12-18
K5V140	50.8	88.9	φ60	M12-18
K5V200	61.9	106.4	φ76	M16-24

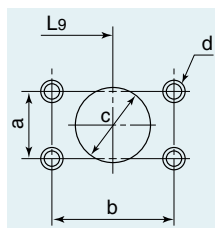

• Flange mounting face for Delivery port (SAE Rule) (mm)

Size	a	b	c	d-Screw depth
K3V63	27.8	57.2	φ25	M12-16
K3V112	23.8	50.8	φ19	M10-16
K3V140	31.8	66.7	φ32	M12-18
K3V280	31.8	66.7	φ32	M12-20
K5V80	27.8	57.2	φ25	M12-16
K5V140	31.8	66.7	φ32	M12-18
K5V200	36.5	79.4	φ38	M16-24

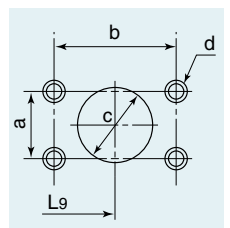

• Drain port (Rule: JIS B 2351) (mm)

Size	a	b	c	d
K3V63	G 1/2	22.6	2.5	19
K3V112	G 3/4	30.8	3.5	20
K3V140	G 3/4	30.8	3.5	23
K3V280	G 3/4	30.8	3.5	23
K5V80	G 1/2	22.6	2.5	19
K5V140	G 3/4	30.8	3.5	20
K5V200	G 3/4	30.8	3.5	23

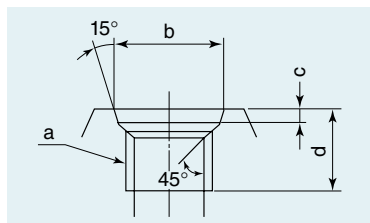

CAUTION FOR INSTRUCTION

1

Mounting Direction and Drain Piping

- The pump shaft should be mounted in the horizontal direction as shown in the figure below.
- The drain line loop must be extended above the top of the pump case.
- The upper drain port should be used, and the drain pipe size must be equal to or larger than the drain port size.
- In case of the pumps with centrifugal pump, the drain lines must be settled on each pump.

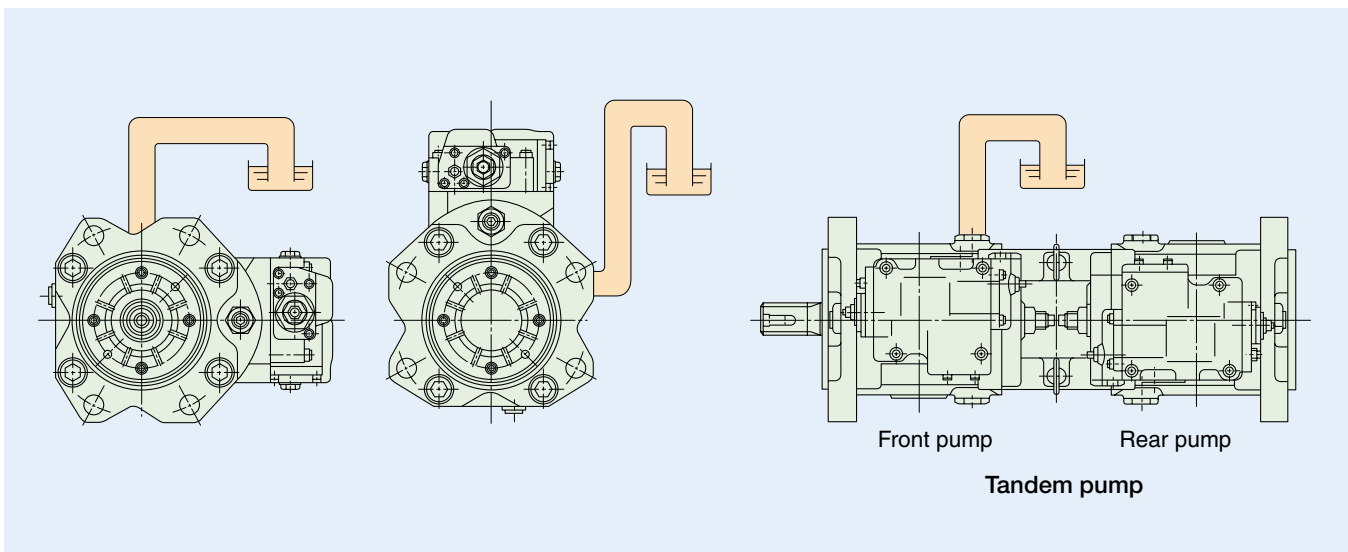

2

Filtration

- For satisfactory service life of these pumps in application, the operating fluid should be continuously filtered to keep at least the cleanliness level of NAS 1638 Class 9.
- A 10 μm filter must be used in the return line and a 80 ~ 150 mesh strainer in the suction lines.

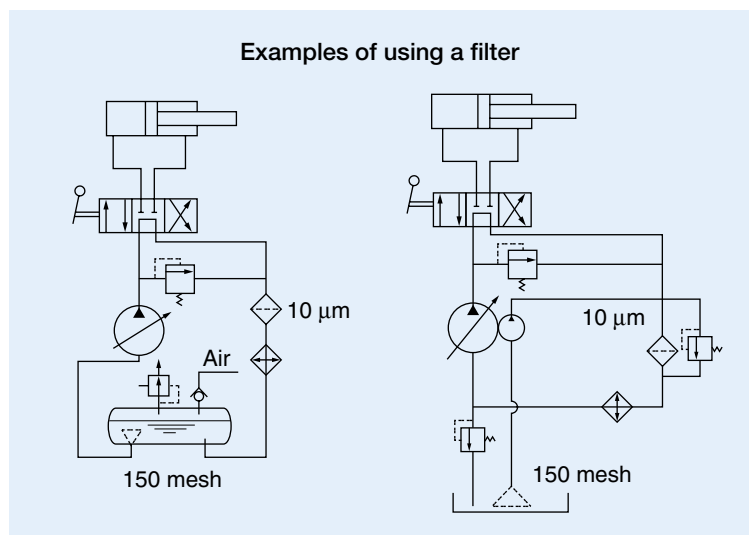

3

Connection of Driving Shaft

- Please use a flexible coupling for connection of the pump drive shaft with an engine flywheel or an electric motor shaft.
- Alignment should be so carried out that the parallel error may be held with in ± 0.03 mm.
- Do not put a radial or thrust load at the shaft end.

4

Starting

- Before starting-up, fill the pump case with system fluid through the case drain connection. Case must remain full of fluid to provide internal lubrication.

5

Case Drain pressure

- Please be careful so that the drain pressure in the casing does not exceed 0.1 MPa normally and 0.4 MPa at its peak.
- A suitable size of drain hose and drain filter should be selected.

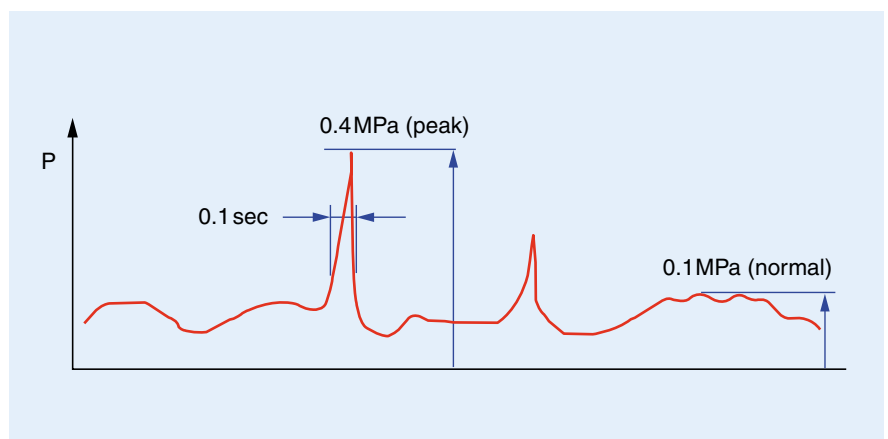

KAWASAKI PRECISION MACHINERY NETWORK

Kawasaki Precision Machinery Ltd.

Head Office / Main Plant

234, Matsumoto, Hasetani-cho, Nishi-ku, Kobe 651-2239, Japan
Phone: 81-78-991-1133 Fax: 81-78-991-3186

Tokyo Office

World Trade Center Bldg., 4-1, Hamamatsu-cho 2-chome, Minato-ku, Tokyo 105-6116, Japan
Phone: 81-3-3435-6862 Fax: 81-3-3435-2023

Kobe Office

Kobe Crystal Tower, 1-3, Higashikawasaki-cho 1-chome, Chuo-ku, Kobe, 650-8680, Japan
Phone: 81-78-360-8608 Fax: 81-78-360-8609

<http://www.khi.co.jp/kpm/>

OVERSEAS SUBSIDIARIES

Kawasaki Precision Machinery (UK) LTD.

Ernesettle Lane, Ernesettle, Plymouth, Devon PL5 2SA, United Kingdom
Phone: 44-1752-364394 Fax: 44-1752-364816

<http://www.kpm-eu.com>

Kawasaki Precision Machinery of America Division of Kawasaki Motors Corp., U.S.A.

5080, 36th St. S.E. Grand Rapids, MI 49512, U.S.A.
Phone: 1-616-949-6500 Fax: 1-616-975-3103

<http://www.kawasakipmd.com>

Flutek, Ltd.

192-11, Shinchon-dong, Changwon, Kyungnam, 641-370 Korea
Phone: 82-55-286-5551 Fax: 82-55-286-5553

KK HYDRAULICS SALES (SHANGHAI) LTD.

B-908 Far East International Plaza 317 Xianxia Rd, Shanghai 200051
Phone: 86-21-62351606 Fax: 86-21-62957080

KAWASAKI HEAVY INDUSTRIES, LTD.

OVERSEAS OFFICES

Seoul Office

c/o Kawasaki Machine Systems Korea, Ltd. 3rd Floor (307), Industrial Complex Support Bldg., 637, Kojan-Dong, Namdong-Gu, Incheon, 405-817, Korea

Phone: 82-32-821-6941 Fax: 82-32-821-6947

Beijing Office

Room No.2602, China World Tower 1, China World Trade Center, No.1 Jian Guo Men Wai Avenue, Beijing 100004, People's Republic of China

Phone: 86-10-6505-1350 Fax: 86-10-6505-1351

Shanghai Office

13th Floor, HSBC Tower, 101 Yin Cheng East Road, Pudong New Area, Shanghai 200120, People's Republic of China

Phone: 86-21-6841-3377 Fax: 86-21-6841-2266

Taipei Office

15th Floor, Fu-Key Bldg., 99 Jen-Ai Road Section 2, Taipei, Taiwan

Phone: 886-2-2322-1752 Fax: 886-2-2322-5009

Bangkok Office

17th Floor, Ramaland Bldg., 952 Rama IV Road, Bangrak, Bangkok 10500 Thailand

Phone: 66-2-632-9511 Fax: 66-2-632-9515

Kuala Lumpur Office

Letter Box No. 162, 6th Floor, UBN Tower, 10 Jalan P. Ramlee 50250, Kuala Lumpur, Malaysia

Phone: 60-3-2070-5141 Fax: 60-3-2070-5148

Jakarta Office

12th Floor, Skyline Bldg., Jl. M. H. Thamrin 9, Jakarta 10340, Indonesia

Phone: 62-21-314-0737 Fax: 62-21-314-1049

OVERSEAS SUBSIDIARIES

Kawasaki Heavy Industries (U.S.A.), Inc.

599 Lexington Avenue, Suite 3901, New York, NY 10022, U.S.A.
Phone: 1-212-759-4950 Fax: 1-212-759-6421

Houston Branch

333 Clay Street, Suite 4310, Houston, TX 77002-4103, U.S.A.

Phone: 1-713-654-8981 Fax: 1-713-654-8187

Kawasaki do Brasil Indústria e Comércio Ltda.

Avenida Paulista 542-6 Andar, Bela Vista, 01310-000, São Paulo, S.P., Brazil

Phone: 55-11-3289-2388 Fax: 55-11-3289-2788

Kawasaki Heavy Industries (U.K.) Ltd.

4th Floor, 3 St. Helen's Place, London EC3A 6AB, U.K.

Phone: 44-20-7588-5222 Fax: 44-20-7588-5333

Kawasaki Heavy Industries (Europe) B.V.

7th Floor, Riverstaete, Amsteldijk 166, 1079 LH Amsterdam, The Netherlands

Phone: 31-20-6446869 Fax: 31-20-6425725

Kawasaki Heavy Industries (H.K.) Ltd.

Room 4211-16, Sun Hong Kai Centre 30 Harbour Road, Wanchai

Hong Kong People's Republic of China

Phone: 852-2522-3560 Fax: 852-2845-2905

Kawasaki Heavy Industries (Singapore) Pte. Ltd.

6 Battery Road, #18-04, Singapore 049909

Phone: 65-6225-5133~4 Fax: 65-6224-9029