



SERVICE MANUAL 1400 SERIES DIGGER MODELS



Example Part Number

1400	155	5	4	F	98	E	5
Model	Ratio	Shaft	Bail Boss	Motor Supplier	Motor Number	Cover	Input

THIS SERVICE MANUAL IS EFFECTIVE:
S/N: 89000 TO CURRENT
DATE: 1-2010 TO CURRENT
VERSION: SMD1400155-54F98E5_AC

NOTE: Individual customer specifications (spindle mounting, sprocket pilot, brake assembly, etc.) may vary from exploded drawing and standard part numbers shown. If applicable, refer to customer drawing for details.

Exploded View Drawing

1400155-54F98E5



X1400155-54F98E5aa 05-21-10 ECN- HWP

MODEL 1400155-54F98E5 DIGGER

ITEM	QTY	DESCRIPTION	PART NO.
1	1	BASE-"F" FLANGLESS	60-004-3014
2	1	OUTPUT SHAFT: 5-1/4" SQUARE	60-004-4222L
3		COVERS	
3A	1	COVER - 440 RING MOUNT	60-004-1934
3B	1	COVER - SAE 'E' - (440)	42-004-2032
4	1	INPUT GEAR	42-004-1532
5	(1)	CARRIER ASSEMBLY-STAGE 1	42-005-0111
5A	1	CARRIER	42-004-1072
5B	3	PLANET GEAR	42-004-1112
5C	3	PLANET SHAFT	42-004-1342
5D	6	WASHER	42-004-1362
5E	60	BEARING ROLLER	01-106-0040
5F	3	SPACER	42-004-1352
5G	3	ROLL PIN	01-153-0220
6		SUN GEARS	
6A	1	INPUT (SUN GEAR)	60-004-1402
6B	1	SUN GEAR	60-004-1792
7	(1)	CARRIER ASSEMBLY- PRIMARY	60-005-2113
7A	1	CARRIER	60-004-1372
7B	3	PLANET GEAR	60-004-1862
7C	3	PLANET SHAFT	60-004-1272
7D	168	BEARING ROLLER	01-106-0050
7E	6	THRUST WASHER	60-004-1881
7F	12	SPACER	60-004-1891
7G	3	RETAINING RING	01-160-0750
7H	3	ROLL PIN	01-153-0150
8		RING GEARS	
8A	1	RING GEAR - STAGE 1	42-004-1042
8B	1	RING GEAR - STAGE 2	60-004-1193
8C	1	RING GEAR - STAGE 3	60-004-1243
9	(1)	CARRIER ASSEMBLY- SECONDARY	60-005-2133
9A	1	CARRIER	60-004-1774
9B	4	PLANET GEAR	60-004-1232
9C	4	PLANET SHAFT	60-004-1262
9D	8	BEARING CONE	01-102-0210
9E	8	BEARING CUP	01-103-0210
9F	4	RETAINING RING	01-160-0490
9G	8	RETAINING RING	01-160-0500
9H	8	WASHER	60-004-1291
9J	8	SHIM	60-004-1321
9K	4	ROLL PIN	01-153-0150
9L	1	PLATE - SEC CARRIER RETAINER	60-004-1352
10		THRUST WASHERS & BEARINGS	
10A	2	BEARING THRUST RACE - PRIMARY	01-112-0350
10B	1	BEARING - PRIMARY THRUST	01-112-0340
10C	2	BEARING THRUST RACE - INPUT	01-112-0400
10D	1	BEARING - INPUT THRUST	01-112-0410
10E	1	BEARING - INPUT THRUST	01-112-0060
11		SEALS & O-RINGS	
11A	2	O-RING	01-402-0840
11B	3	O-RING	01-402-0660
11C	1	OUTPUT SHAFT SEAL	01-405-0810
11D	1	O-RING	01-402-0670
12		OUTPUT SHAFT BEARINGS	
12A	1	OUTER CONE	01-102-0190
12B	1	OUTER CUP	01-103-0190
12C	1	INNER CONE	01-102-0220
12D	1	INNER CUP	01-103-0220
13		HARDWARE	
13A	6	SHCS (3/8-16 X 1) GR8	01-150-1110
13B	20	HHCS (5/8-11 X 4-1/2) GR8	01-150-0870
13C	20	LOCKWASHER (5/8)- ZINC PLATED	01-166-0040
13D	3	FHS C.S. (3/8-24 X 1)GR8	01-150-1590
13E	20	HHCS (3/4-10 X 11.5) GR8	01-150-1720
13F	20	HARDWASHER (3/4 X 1.25 OD)	01-166-0350
13G	4	HHCS (3/4-10 X 1.75) GR8	01-150-1890
13H	4	LOCKWASHER (3/4 MED)	01-166-0360
14		PLUGS	
14A	4	PIPE PLUG (3/4 NPT MAGNETIC)	01-207-0100
14B	2	INTERNAL HEX PLUG	01-208-0030
15		MISCELLANEOUS	
15A	1	SEAL CARRIER	60-004-1922
15B	1	BAIL ASSEMBLY	60-005-2153
15C	*	SHIM	60-004-1311
15D	1	LOCK RING	60-004-1472
15E	1	RETAINING RING	01-160-0690
15F	1	RETAINING RING	01-160-0826
15G	1	SPLIT RING (L-SEGMENT)	60-004-1482
15H	1	RETAINING RING	01-160-0510
15I	1	ADAPTER	60-004-1902
16	1	MOTOR	01-304-0980

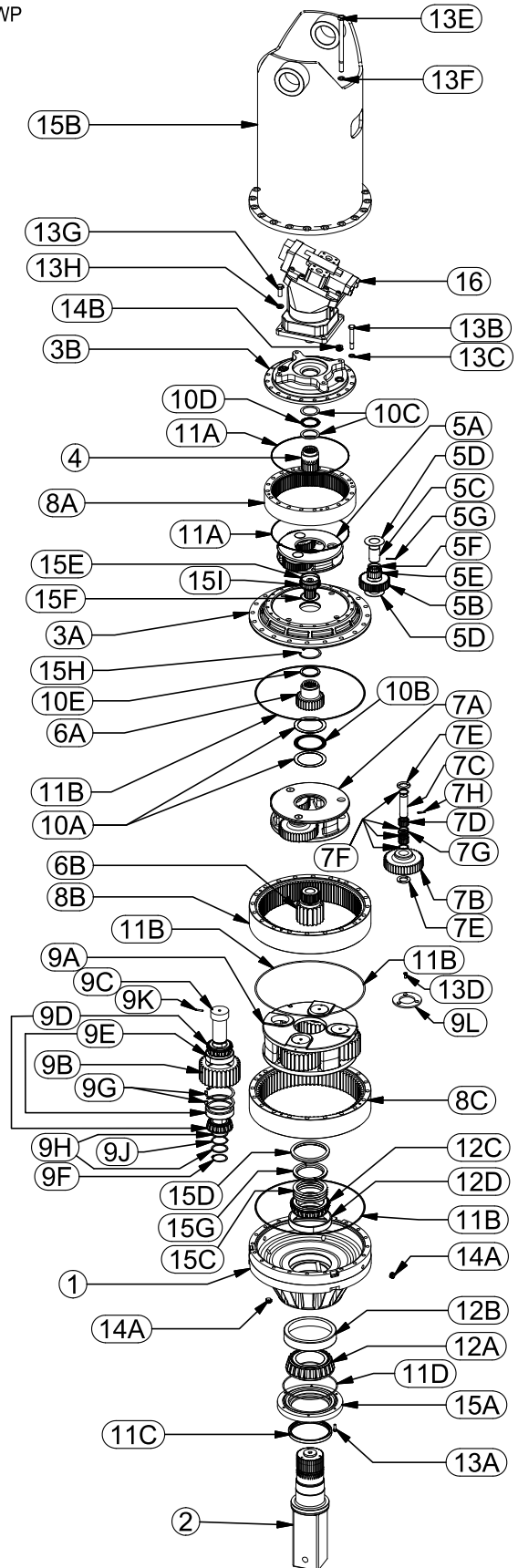

LUBRICATION & MAINTENANCE

Using the chart below, determine an appropriate lubricant viscosity. Use only EP (extreme pressure) or API GL-5 designated lubricants. Change the lubricant after the first 50 hours of operation and at 500 hour intervals thereafter. The auger drive should be partially disassembled to inspect gears and bearings at 1000 hour intervals.



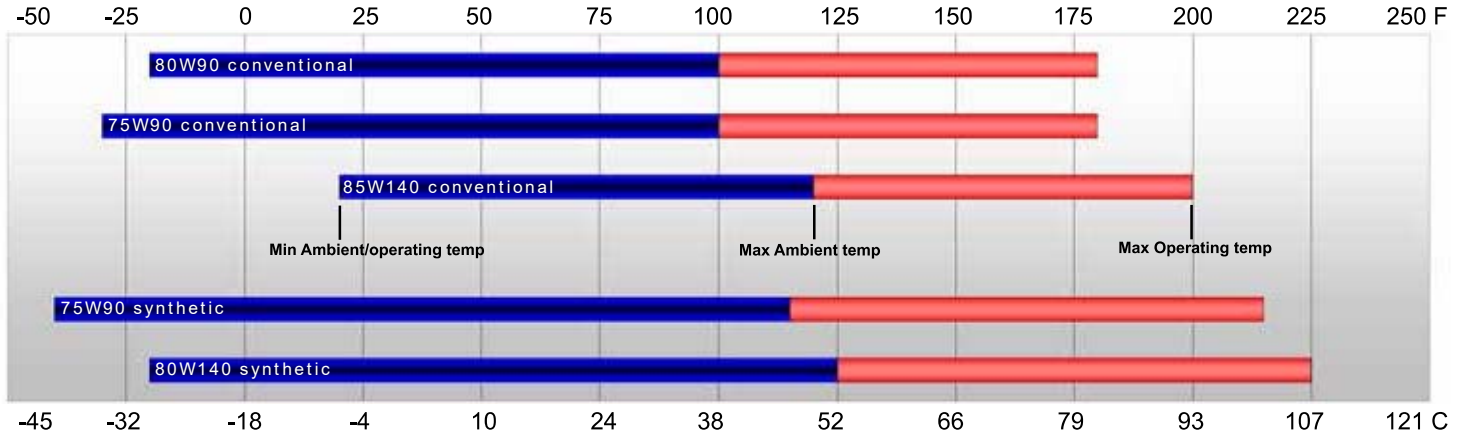

Recommended ambient and operating temperatures for conventional and synthetic gear lubricants



Note: Ambient temperature is the air temperature measured in the immediate vicinity of the gearbox. A gearbox exposed to the direct rays of the sun or other radiant heat sources will operate at higher temperatures and therefore must be given special consideration. The max operating temp must not be exceeded under any circumstances, regardless of ambient temperature.

If your unit was specified “shaft up” or with a “-Z” option, a grease zerk was provided in the base housing. For shaft-up operation, the output bearing will not run in oil and must be grease lubricated. Use a lithium based or general purpose bearing grease sparingly every 50 operating hours or at regular maintenance intervals. Over-greasing the output bearing should be avoided as it tends to fill the housing with grease and thicken the oil

ESKRIDGE MODEL D1400 OIL CAPACITIES

Operating Position	Oil Capacity			Oil Level
	Single stage	Double stage	Triple stage	
 Horizontal Shaft	-	-	-	To horizontal centerline of auger drive 
 Vertical Shaft (Pinion Down)	-	10.25 gal	-	To midway on upper/primary gear set 



WARNING: While working on this equipment, use safe lifting procedures, wear adequate clothing and wear hearing, eye and respiratory protection.

ESKRIDGE PART NUMBER INTERPRETATION

Note: All non custom Eskridge Geardrives are issued a descriptive part number which includes information regarding the Model, means of shaft retention, base style, shaft style, input mounting, input shaft size, overall ratio and various available options. For a detailed breakdown of this information, please refer to Eskridge product specification sheets found at: <http://www.eskridgeinc.com/diggers/diggerprodspecs.html>

Unit Disassembly Procedure

- 1) Scribe a diagonal line across the outside of the unit from the bail (15B) to the base (1) before disassembly to aid in the proper positioning of pieces during reassembly.
- 2) Remove magnetic drain plugs (14A) and drain oil from unit. The oil will drain out faster and more completely if warm.
- 3) Remove the twenty hex-head capscrews (13E) and lockwashers (13F).
- 4) Separate bail (15B) from ring gear adapter (3A) and remove from digger assembly.
- 5) Install two hex-head capscrews (13E) into ring gear adaptor (3A) to retain gearbox assembly together.
- 6) Remove motor (16) from cover (3B).
- 7) Remove the twenty hex-head capscrews (13B) and lockwashers (13C).
- 8) Remove cover (3B), thrust bearings (10C & 10D), remove input gear (4). Inspect o-ring (11A); discard if damaged or deformed.
- 9) Remove retaining ring (15E) from stage II sun gear. Lift Stage I planet carrier assembly (5) out of the unit. Remove ring gear (8A) and inspect o-ring (11A); discard if damaged or deformed.
- 10) Remove two hex-head capscrews (13E) and ring gear adapter (3A). Inspect o-ring (11B) as before; discard if damaged.
- 11) Remove thrust washers and bearings (10A, 10B & 10E).
- 12) Remove adaptor (15I), sun gear (6A) and carrier assembly (7). Remove the Stage II ring gear (8B). Inspect o-ring (11B); as before, discard if damaged.
- 13) Remove Stage III sun gear (6B) from Stage III carrier assembly (9).
- 14) Remove the three 3/8-24 flat head capscrews (13D) securing the carrier retaining plate (9L) to the output shaft (2).
- 15) Remove remaining ring gear (8C) and Stage III carrier assembly (9). Inspect gear to gear and gear to base o-ring(s) (11B), discard and replace any damaged or deformed o-rings.
- 16) The unit is now separated into subassemblies. The area(s) requiring repair should be identified by thorough inspection of the individual components after they have been cleaned and dried.

Stage I Carrier Subassembly

(Items 5A, 5B, 5C, 5D, 5E, 5F & 5G)

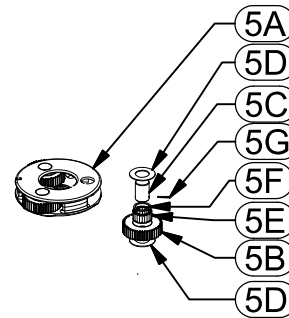

Disassembly

- 1) Rotate planet gears (5B) to check for abnormal noise or roughness in bearings (5E) or planet shafts (5C). If further inspection or replacement is required, proceed as follows.

NOTE: Support only the carrier (5A) while pressing out planet shafts.

- 2) Drive roll pins (5G) completely into the planet shafts (5C).
- 3) Press or drive planet shafts (5C) out of carrier (5A).
- 4) Remove planet gears (5B) and thrust washers (5D) from the carrier (5A).
- 5) Inspect the planet gear (5B), bearing bore, planet shaft (5C) and rollers (5E). Check for spalling, bruising or other damage. Replace components as necessary; rollers should be replaced only as a set of 20.
- 6) Check primary planet shafts (5C) for any abnormal wear, especially ones where bearings needed to be replaced. If any abnormal wear is found, replace planet shafts.
- 7) Use 3/16 inch pin punch to remove roll pins (5G) from planet shafts (5C).

NOTE: If either the rollers or the planet shafts (pins) are damaged, both components should be replaced.

Reassembly

- 1) Rebuild Stage I planet carrier assembly in reverse order using any needed new parts.
- 2) Install rollers in gear as follows:
 - a) Set planet washer (5D) on work table with planet gear (5B) positioned on top of washer. Center the planet washer to the planet gear as closely as possible.
 - b) Center the planet shaft (5C) in the planet gear (5B) bearing bore. Install roller spacer (5F) onto planet shaft.
 - c) Begin placing rollers (5E) around the shaft (5C). There should be clearance for the last roller to slide in. Be sure to install 20 rollers in each planet gear.
 - d) Place washer (5D) over the gear (5B) onto the shaft (5C).
 - e) Carefully slide the assembly off the table, holding the lower planet washer (5D) and planet gear (5B).

- f) Slide the planet shaft (5C) out of the assembly and slide the assembly into the carrier.
 - g) Align the planet gear/bearing assembly inside the carrier and install the planet shaft through the entire assembly.
- 3) Planet shafts (5C) should be installed with the chamfered end of the 3/16 inch hole towards the outside diameter of the carrier (5A); this will aid in alignment of holes while inserting roll pins (5G).
 - 4) Drive roll pin (5G) into the carrier hole and into the planet shaft to retain the parts. Repeat for remaining planet gears.

Stage II Carrier Subassembly

(Items 7A, 7B, 7C, 7D, 7E, 7G, & 7H)

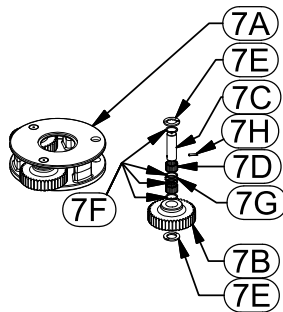

Disassembly

- 1) Rotate planet gears (7B) to check for abnormal noise or roughness in bearings (7D). If further inspection or replacement is required, proceed as follows.
- 2) Drive roll pins (7H) completely into the planet shafts (7C).
- 3) Slide planet shafts (7C) out of carrier (7A).
- 4) Remove planet gears (7B), washers (7E) and rollers (7D) from carrier (7A).
- 5) Inspect the planet gear (7B), bearing bore, planet shaft (7C) and rollers (7D). Check for spalling, bruising or other damage. Replace components as necessary; rollers should be replaced only as a set of 56.
- 6) Remove roll pins (7H) from primary planet shafts (7C) using a 3/16 inch pin punch.

Reassembly

- 1) Rebuild primary planet carrier assembly in reverse order using any needed new parts.
- 2) Install rollers in gear as follows:
 - a) Set planet gear (7B) onto table. Install one roller spacer (7F) into planet gear bore and seat on internal retaining ring (7G).
 - b) Center the planet shaft (7C) in the planet gear (7B) bearing bore.
 - c) Begin placing rollers (7D) around the shaft (7C). There should be clearance for the last roller to slide in. Be sure to install 28 rollers in each planet gear.

- d) Place spacer washer (7F) onto planet rollers.
 - e) Place thrust washer (7E) onto planet gear (7B) remove planet shaft.
 - f) Carefully slide the assembly off the table and rotate 180 degrees placing thrust washer onto table. Repeat steps 1 (a-f).
 - g) Align the planet gear/bearing assembly inside the carrier and install the planet shaft through the entire assembly.
- 3) Planet shafts (7C) should be installed with the chamfered end of the 3/16 inch hole towards the outside diameter of the carrier (7A); this will aid in alignment of holes while inserting roll pins (7G).
 - 4) Drive roll pin (7G) into the carrier hole and into the planet shaft to retain the parts. Repeat for remaining planet gears.

Stage III Carrier Subassembly

(Items 9A, 9B, 9C, 9D, 9E, 9F, 9G, 9H, 9J & 9L)

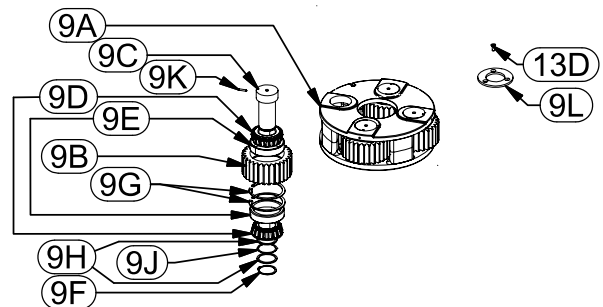

Disassembly

- 1) Rotate planet gears (9B) to check for abnormal noise or roughness in bearings (9D, 9E). If further inspection or replacement is required, proceed as follows.
- 2) Removing retaining ring (9F), washer (9H) and shims (9J) from planet shaft (9C).
- 3) Press planet shafts (9D) out of carrier (9A).
- 4) Remove planet gears (9B) and washer (9H) from carrier.
- 5) Inspect the planet gear (9B), bearing cone (9E), bearing cup (9D) and planet shaft (9C). Check for spalling, bruising or other damage. Replace components as necessary; bearing need to be replaced as a cup and cone set.
- 6) Replace any parts where abnormal wear is found.

Reassembly

- 1) Rebuild Stage III planet carrier assembly in reverse order using any needed new parts.
- 2) Install bearing cones (9E) into planet gear bearing cups (9D). Place washer (9H) onto interior carrier spot faced surface.
- 3) Insert planet gear assembly into carrier (9A).

Slide planet shaft (9C) into carrier planet assembly and align planet pin notch with roll pin in carrier.

- Place shims (9J) and washer (9H) onto planet shaft. Install retaining ring (9F). Rotate planet gears by hand to test bearing preload. Correct bearing preload on the planet gears requires 50-75 in-lbs rotating torque. If gear doesn't rotate remove a shim and test again until a smooth loaded rotation is developed. Repeat for remaining planet gears.

Base Subassembly

(Items 1, 2, 11A 11C, 12A, 12B, 12C, 12D, 13A, 14, 15A, 15C, 15D, & 15E)

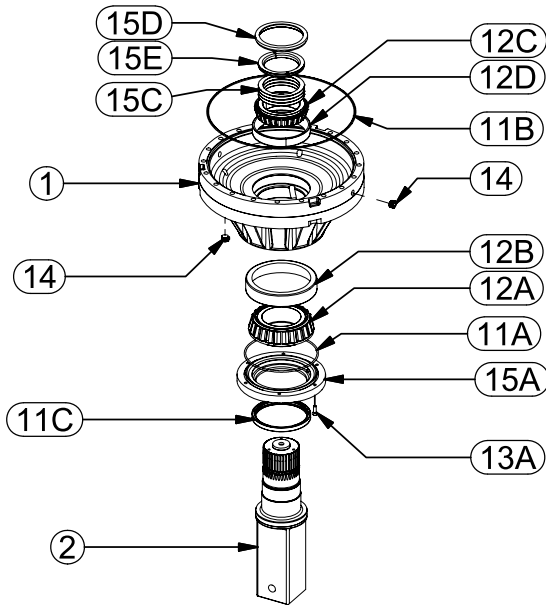

Disassembly

- Remove the seal carrier retaining screws (13A) and seal carrier (15A) from unit. Inspect seal (11C) and o-ring (11A) for signs of wear or damage and replace as necessary.
- Remove the lock ring (15D) using a heel bar or puller; if using a heel bar, be sure not to pry against the cage of the inner output shaft bearing (12C). Remove the split ring segments (15E) and shims (15C).

Caution: Since the output shaft is no longer retained, care should be taken to avoid personal injury. Care should also be taken not to damage it when it is pressed through base.

- Base (1) should be set pinion side down, as shown, on a plate or table. Press output shaft through the bottom of base by applying a load to top end (internal end) of shaft until it passes through inner shaft bearing cone (12C).

Note: Removing the shaft from the base assembly damages the shaft seal and the seal will need to be replaced.

- A gear puller may be used to remove the outer bearing cone (12A) from the shaft (2). If reusing old bearing cone, do not pull on or damage roller cage.
- Inspect inner and outer bearing cups (12A, 12B, 12C & 12D). If cups are damaged, drive them out using a brass drift and utilizing the bearing knock-out notches in the base (1)

Reassembly

- Clean all foreign material from magnetic oil plug (14) located on the side of the base (1).
- Place base (1) (output side up, opposite shown) on the table.
- Apply a layer of lithium or general purpose bearing grease to the roller contact surface of outer bearing cup (12A).
- Press outer bearing cone (12B) (large end down as shown) onto the shaft until it seats against the shoulder.

Note: Press bearing cone onto output shaft by pressing on inner race only. DO NOT press on roller cage, as it may damage bearing.

- Place the shaft (2) with the bearing (12A) into the base (1).
- Flip this assembly, resting the base (1) on the end of the output shaft (2).
- Apply a layer of lithium or general purpose bearing grease to the roller contact surface of the inner cup (12D). Press the inner bearing cone (12C) (large end up as shown) onto the shaft (2) until it is seated against inner bearing cup (12D).
- Without the shaft seal (11C) installed, the preload may result in a rolling torque that varies between 50 to 300 in-lb. The bearing preload should be tailored to your application; a low-speed application may require a high pre-load, high-speed applications usually benefit from low pre-load. Adding shims (15C) will increase the pre-load on the bearing set. Determine your pre-load requirement and install shims to obtain this pre-load. Install the Load-N-Lock® segments (15E) over the shims (15C) and into the groove in the shaft (2). Finally, install the lock ring (15D) over the segments (15E).
- Install o-ring (11A) onto seal carrier (15A). Lubricate inner lip of new shaft seal (11B) and slide seal carrier assembly onto the shaft (2). Install seal carrier fasteners (13A) and torque to 30 ft-lbs.

All subassembly service or repairs should be complete at this time. Continue to Unit Assembly to complete unit buildup.

Unit Assembly

- 1) When all subassemblies are complete, the unit is ready to be assembled. During assembly a bead of Loctite 635 needs to be placed in between the mating surfaces of the base, ring gears, cover, and bail.
- 2) Install the Stage III carrier assembly onto the output shaft; align the splines of the carrier (9A) with the splines of the shaft (2) and slide the carrier onto the shaft.
- 3) Install carrier retaining plate (9L) & secure using 3/8-24 Flat-head capscrews (13D).
- 4) Lubricate o-ring (11B) and install on the pilot of the Stage III ring gear (8C).
- 19) Install motor (16) onto cover (3B) and align motor shifting mechanism with bail relief hole. Install motor fasteners.
- 20) Remove two temporarily fasteners installed in step 10. Place bail (15B) onto assembly and aligning holes in bail and cover using scribed line made during disassembly as a reference. Install and torque the 20 3/4-10 hex head cap-screws (13E) with lockwashers (13F). **The torque for the capscrews is 380 ft-lbs dry, 280 ft-lbs if fasteners are lubricated.**
- 21) Fill the unit to the proper level, as specified, with GL5 EP 80/90 gear oil after it is sealed with a brake and/or motor.

The digger is now ready to use.

Caution: Hold ring gear by outside or use lifting device to prevent injury.

- 5) Install Stage III sun gear (6B) into Stage III carrier assembly.
- 6) Align gear teeth of ring gear (8C) with the gear teeth of the planet gears (9B) and place on base. Align mounting holes of ring gear with holes in base. Using the scribed line made during disassembly for reference.
- 7) Slide Stage II carrier (7A) onto Stage III sun gear (6B) and install Stage II sun gear (6A).
- 8) Lubricate o-ring (11B) and install on the pilot of the Stage II ring gear (8B).
- 9) Align gear teeth of ring gear (8B) with those of the planet gears and place on Stage III ring gear. Align mounting holes of ring gear with holes in base. Use the scribed line made during disassembly for reference.
- 9) Lubricate o-ring (11B) and install on the pilot of the Stage I ring gear adaptor (3A).
- 10) Noting the scribed line made during disassembly, install the Stage I gear adapter (3A) and temporarily install two fasteners (13E) to hold assembly together.
- 11) Install the Stage I adaptor (15I) into Stage II input gear. Place retaining ring (15F) onto lower adaptor groove and install Stage I carrier assembly (5) onto adaptor. Install upper retaining ring (15E) onto adaptor.
- 12) Align gear teeth of ring gear (8A) with the gear teeth of the planet gears (5B) and place on ring adaptor. Align mounting holes of ring gear with holes in base. Using the scribed line made during disassembly for reference.
- 13) Install the input gear (4) then thrust bearings in the following order onto the input gear: one thrust washer (10C), thrust bearing (10D), and one thrust washer (10C).
- 15) Lubricate o-ring (11A) and install on the pilot of the cover (3B).
- 16) Noting the scribed line made during disassembly, install the cover (3).
- 17) Install and torque the 20 5/8-11 hex-head cap-screws (13B) with lockwashers (13C). The torque for the cap-screws to **55 ft-lbs dry**.
- 18) Ensure the unit spins freely by using a splined shaft to drive the input gear (4).