

- **Accurate measurement of spool valve position**
- **Measurement range of 10-25mm**
- **Hall-effect, non-contacting sensing**
- **Working pressure up to 420bar (5880psi)**
- **Burst pressure up to 600bar (8400psi)**
- **Analog output – 0.5-4.5V or 0.2-4.8V**
- **4-20mA output option**
- **PWM output option**
- **Supply voltage – 5Vdc and 9-32Vdc**
- **Choice of output polarities**
- **M18 mounting thread**
- **ISO6149 compliant**
- **Operating temperature -40°C to 85°C**
- **Sealed to IP69k**
- **AMP or Deutsch connector options**
- **Flying-lead option**



Modern day safety directives for machines, including on- and off-highway vehicles, require that correct hydraulic valve operation is assured. This means that spool valves often need to be fitted with sensors that can measure the actual valve position and feed this information back to the machine's controlling electronics, which can then determine if the valve is in a safe position for the intended operation. Traditionally, these small-stroke linear sensors have been based around inductive technology but a more cost-effective approach is to use Hall-effect sensing, which is also non-contacting so can achieve equal levels of reliability.

The VPT351 can provide accurate, positional measurement over a span of 10-25mm and is designed specifically for the monitoring of hydraulic valves. The transducer can operate from either a 5V supply or an unregulated supply in the range of 9-32V, so making it suitable for vehicle applications.

A choice of output types is available: analog voltage in two spans, 0.5-4.5V or 0.2-4.8V; 4-20mA current loop; or one of three PWM frequencies. Each of the output types can have its full span set to correspond to the selected measurement range, while the polarity of the output is also configurable. The sensor and associated electronics are also shielded against electromagnetic disturbances.

Mounting to the valve block is via a standard M18 thread and an O-ring is fitted to ensure reliable sealing at operating pressures up to 420bar (5880psi), while being able to withstand periods of pressure as high as 600bar (8400psi).

Connection options are over-molded, industry-standard AMP Superseal or Deutsch DT04 series connectors, or simple flying leads for customer termination. Dependent on the type of connector used, sealing as high as IP69k can be achieved.



CONTENTS

Configuration & Ordering Codes	3
Stroke Length	3
Output.....	3
Direction	4
Cable.....	4
Connector.....	4
Installation	5
Mechanical	5
Sensor.....	5
Port Mounting Details.....	5
Electrical Connections	6
Flying Leads (C0).....	6
AMP Superseal (C1)	6
Deutsch DT04 (C2)	6
Specifications	7
Electrical.....	7
Voltage Outputs.....	8
PWM Outputs	9
Current Outputs.....	10
Mechanical	11
Environmental	11

© 2015 Curtiss-Wright. All rights reserved.

Curtiss-Wright accepts no responsibility for possible errors in catalogs, brochures and other printed material. Curtiss-Wright reserves the right to alter its products without prior notice. This also applies to products already ordered provided that such alterations can be made without affecting agreed specifications. All trademarks in this material are properties of their respective owners.



CONFIGURATION & ORDERING CODES

VPT351-XX-XX-X-XX-XX

Type	Stroke Length	Output	Direction	Cable	Connector
VPT351	XX	XX	X	X	XX
	10-25	A1	1	P2	C0
		A3	2		C1
		A5			C2
		P1			
		P2			
		P3			

STROKE LENGTH

VPT351-~~XX~~-XX-X-XX-XX

Code	Description
XX	10-25mm in 1mm increments

OUTPUT

VPT351-XX-~~XX~~-X-XX-XX

Code	Description
A1	Analog voltage: 10-90% of 5V supply or 0.5-4.5V of 9-32V supply
A3	Current Output: 4-20mA
A5	Analog voltage: 4-96% of 5V supply or 0.2-4.8V of 9-32V supply
P1	PWM: 244Hz
P2	PWM: 500Hz
P3	PWM: 1kHz



DIRECTION

VPT351- XX-XX-X-XX-XX

Code	Description
1	Rising with shaft extension
2	Falling with shaft extension

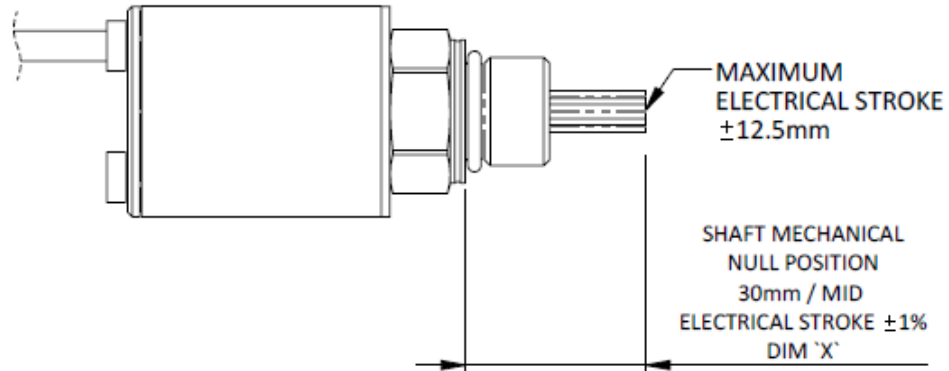

CABLE

VPT351- XX-XX-X-XX-XX

Code	Description
P2	0.2m cable

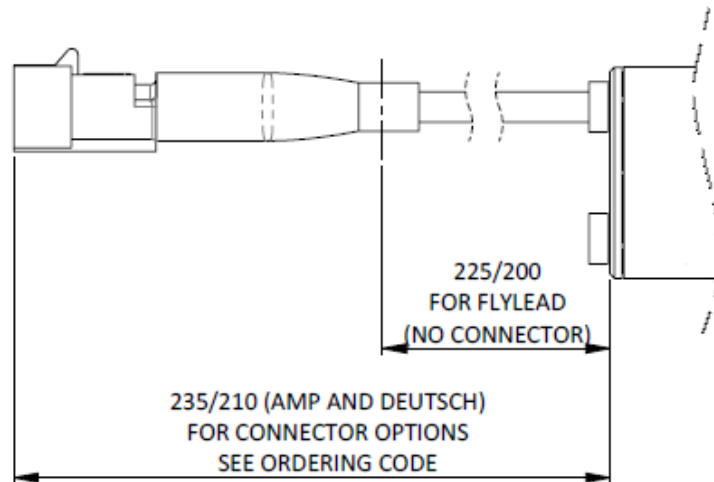

Dimensions in mm

CONNECTOR

VPT351-XX-XX-X-XX-XX

Code	Description
C0	No connector
C1	AMP Superseal 1.5 series 4P CA
C2	Deutsch DT04-4P-CE02



INSTALLATION

MECHANICAL

Sensor

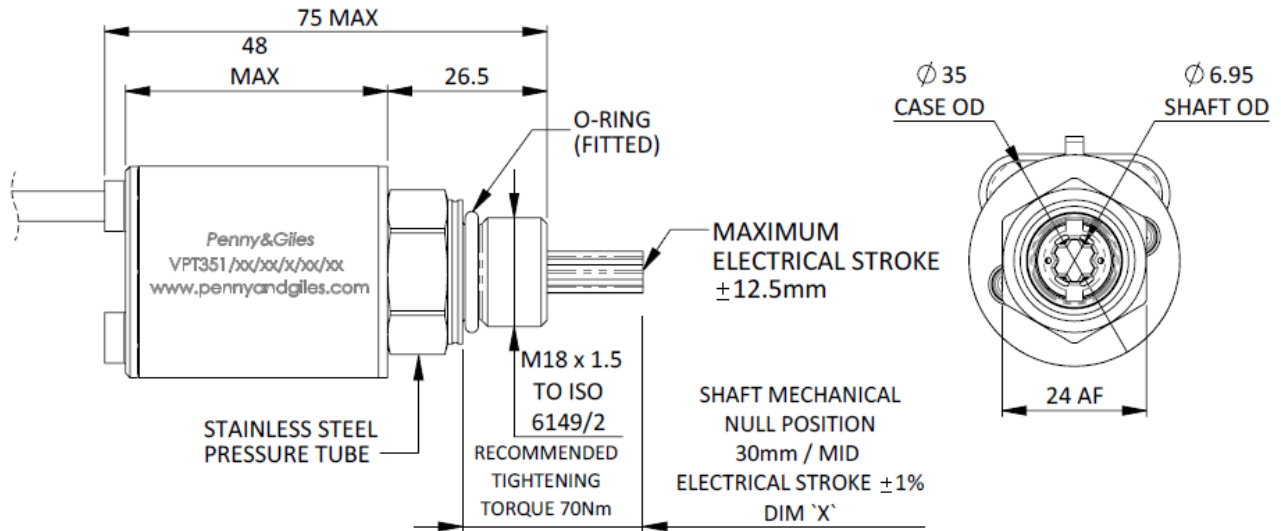

Dimensions in mm

Port Mounting Details

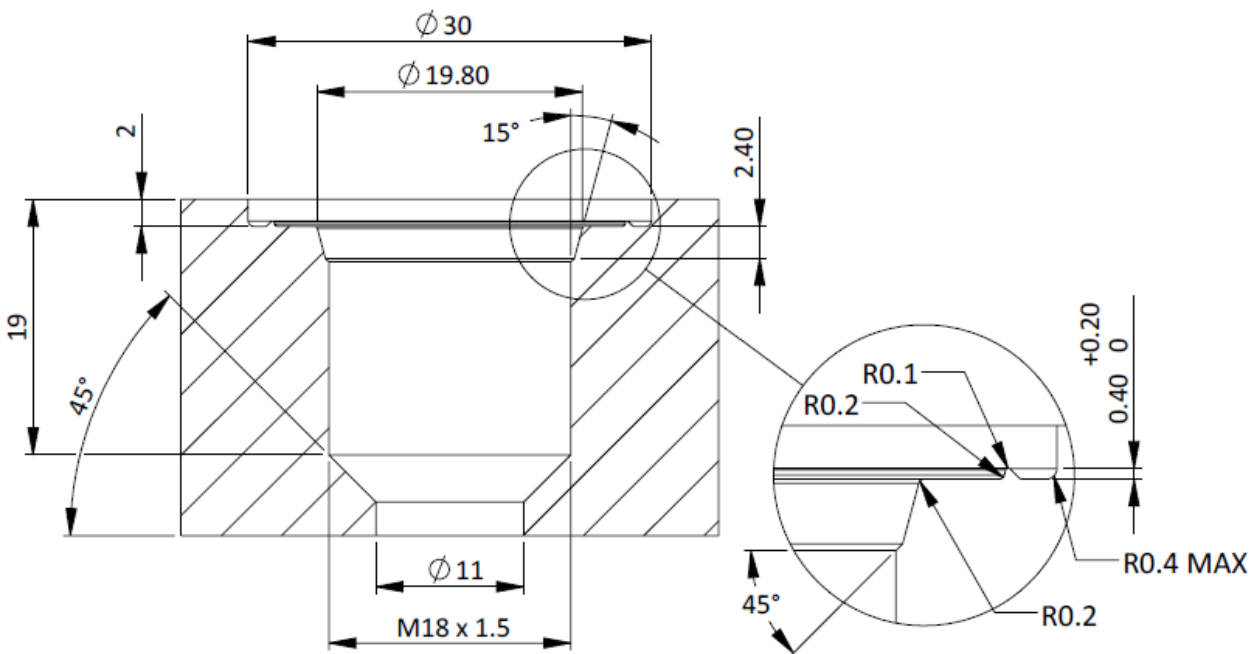

Dimensions in mm



ELECTRICAL CONNECTIONS

Flying Leads (C0)

Color	Function
RED	+V supply
BLUE	5V Output
YELLOW	Supply GND
WHITE	4-20mA output

AMP Superseal (C1)

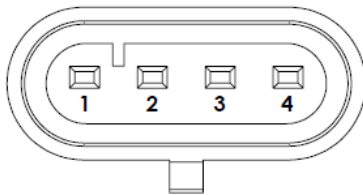

AMP 1.5 Superseal 282106-1

Mating Part No: 282088-X (plug) & 183025-1 (pins)

Pin	Function
1	+V supply
2	5V Output
3	Supply GND
4	4-20mA output

Deutsch DT04 (C2)

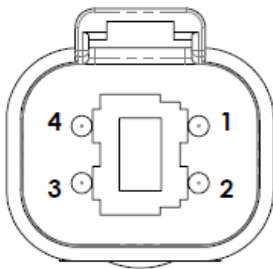

Deutsch DT04 4P-CE02 with gold contact 0460-202-1631

Mating Part No: DT06-4S-**** (plug) & 0462-201-1631 (pins)

Pin	Function
1	+V supply
2	5V Output
3	Supply GND
4	4-20mA output



SPECIFICATIONS

ELECTRICAL

MEASUREMENT RANGE	10-25mm in 1mm increments
SUPPLY VOLTAGE	5Vdc \pm 0.5Vdc or 9-32Vdc unregulated
SUPPLY CURRENT	< 25mA (voltage/PWM output), < 50mA (current output)
SUPPLY REVERSE POLARITY PROTECTION	Voltage and PWM output options only
SHORT-CIRCUIT PROTECTION TO GND	Yes
SHORT-CIRCUIT PROTECTION TO SUPPLY	Yes (when used with 5V supply only for voltage/PWM outputs)
OVER-VOLTAGE PROTECTION	Up to 36Vdc (-40°C to +60°C)
POWER-ON SETTLEMENT	< 1s
RESOLUTION	12-bit (0.025% of measurement range)
LINEARITY (ABSOLUTE)	< \pm 1% FS max. (\pm 3mm), < \pm 2% FS max. (\pm 12.5mm)

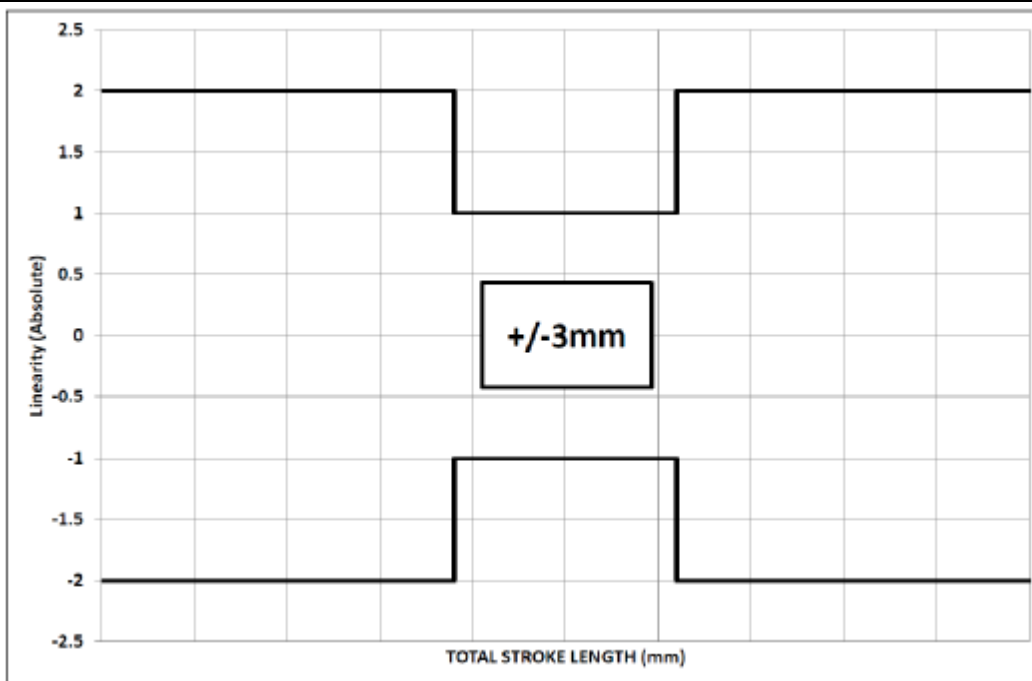

HYSTERESIS	< \pm 0.1% FS max.
REPEATABILITY	< \pm 0.2% FS max.
TOTAL ERROR BAND	\leq \pm 2.2%FS max (-25°C to +85°C), \leq \pm 3.2%FS max (-25°C to +115°C)
TEMPERATURE COEFFICIENT	< \pm 300ppm /°C (-25°C to +85°C)
ELECTRICAL RESPONSE TIME	\leq 3ms



VOLTAGE OUTPUTS

OUTPUT RANGE A1 (5Vdc SUPPLY)	10-90% ±1% of Vsupply over measurement range
OUTPUT RANGE A1 (9-32Vdc SUPPLY)	0-5-4.5V ±3% absolute over measurement range
MONOTONIC RANGE	5%/0.25V to 95%/4.75V nominal
OUTPUT RANGE A5 (5Vdc SUPPLY)	4-96% ±1% of Vsupply over measurement range
OUTPUT RANGE A5 (9-32Vdc SUPPLY)	0.2-4.8V ±3% absolute over measurement range
MONOTONIC RANGE	2%/0.1V to 98%/4.9V nominal

Voltage output law example

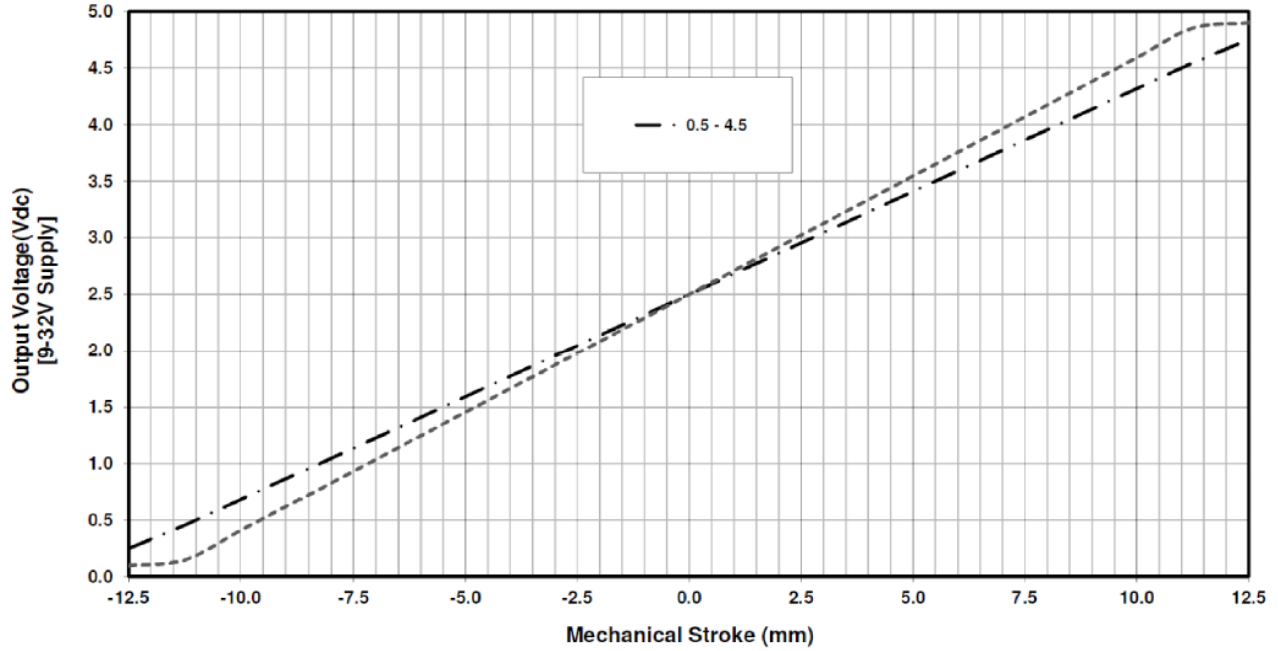

LOAD RESISTANCE	10kΩ min. (resistive to GND)
OUTPUT NOISE	<0.05% FS max.



PWM OUTPUTS

PWM FREQUENCY	244Hz, 500Hz or 1kHz $\pm 20\%$
PWM LEVELS (5Vdc SUPPLY)	0V and $V_{supply} \pm 1\%$
PWM LEVELS (9-32Vdc SUPPLY)	0V and 5V $\pm 3\%$ nominal
DUTY CYCLE	10-90% over measurement range
MONOTONIC RANGE	5-95% nominal
LOAD RESISTANCE	10k Ω min. (resistive to GND)
RISE/FALL TIME	<20 μ s typical

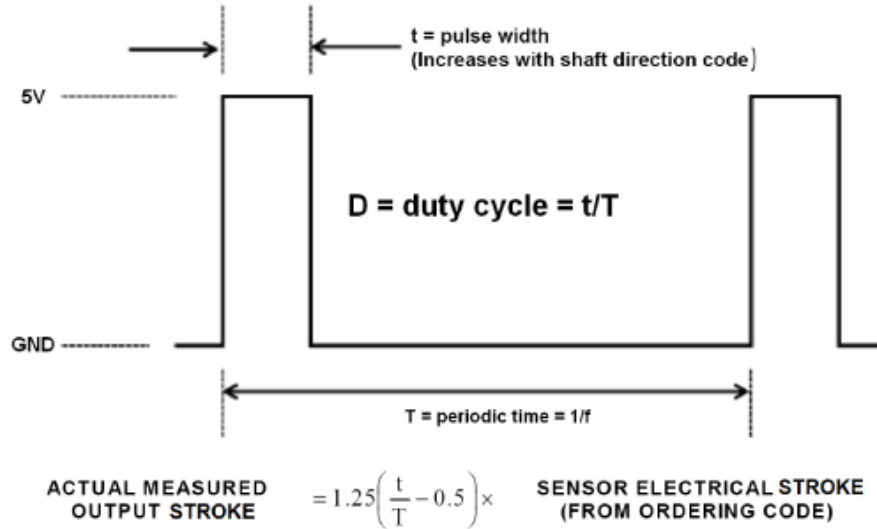



CURRENT OUTPUTS

OUTPUT RANGE	4-20mA over measurement range
MONOTONIC RANGE	2-22mA nominal
OUTPUT LOAD	20-500Ω
RESIDUAL RIPPLE SUPPLY VOLTAGE	<5%

Current output law example

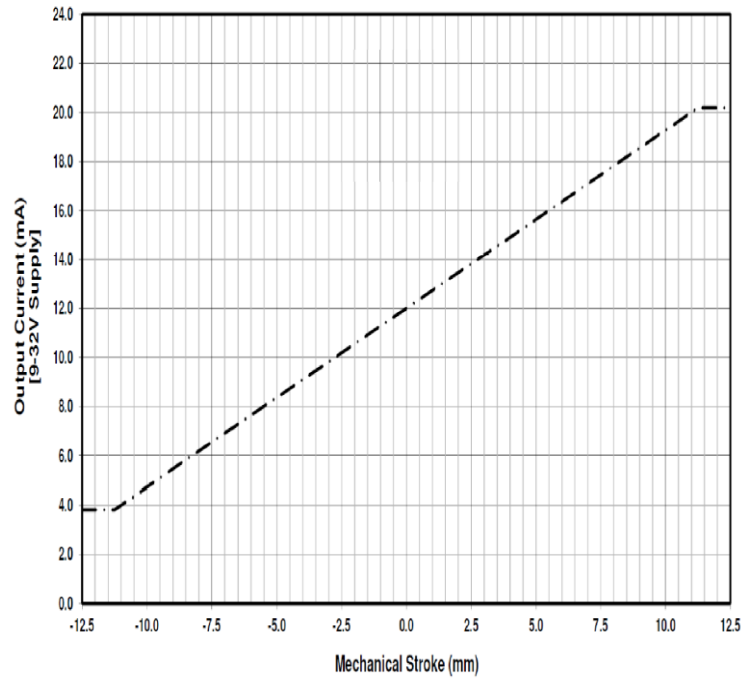

OUTPUT NOISE	<0.15% FS max.
--------------	----------------



MECHANICAL

MECHANICAL RANGE	25mm min
MAXIMUM OPERATING SPEED	10m/s (shaft response time)
WEIGHT	<200g
SPRING FORCE	<8N
WORKING PRESSURE (MAX)	420 Bar
BURST PRESSURE (MAX)	600 Bar
MOUNTING	M18x1.5, ISO6149
O-RING	Supplied, 15.3x2.2mm NBR90

ENVIRONMENTAL

OPERATING TEMPERATURE RANGE	-40°C to +85°C
STORAGE TEMPERATURE RANGE	-40°C to +115°C
SEALING	IP68, IP69K (manufacturer's ratings apply to connectors)
VIBRATION	BS EN 60068-2-64:1995 section 8.4 (31.4gn rms) 20-2000Hz random
SHOCK	1m drop onto concrete
LIFE	10 million cycles (spring life)
MTTFd	173 years
ELECTROMAGNETIC INTERFERENCE	EN 61000-4-3:1999 80-1000MHz & 1.4-2.7GHz Voltage/PWM output to 100V/m Current output to 75V/m
SALT SPRAY	BS EN 60068-2-52 test Kb severity 2

IMPORTANT INFORMATION

Whilst Curtiss-Wright Industrial Group - Penny & Giles has designed this sensor to meet a range of applications it is the responsibility of the customer to ensure it meets their specific requirement.

Penny & Giles Controls Ltd makes no warranty or representation in respect of product fitness or suitability for any particular design application, environment, or otherwise, except as may subsequently be agreed in contract for the sale and purchase of products. Customers should therefore satisfy themselves of the actual performance requirements and subsequently the product's suitability for any particular design application and the environment in which the product is to be used.

Continual research and development may require change to products and specification without prior notification.

All trademarks acknowledged.